



Spare Parts Catalogue danfoil ConCorde II

Options

danfoil®
- less is more...



Hovednummer:
+45 98 67 42 33

Vagttелефон: (april til oktober):
+45 40 43 12 33

Fax:
+45 98 67 34 88

E-mail:
info@danfoil.dk

Adresse:
danfoil a/s
Jellingvej 14
DK-9230 Svenstrup
www.danfoil.dk

Servicepartner
TBS Maskinpower A/S
Ørderup Kirkevej 43
6520 Toftlund
Tlf. 75 38 11 22
www.tbs.dk

Snertinge Maskinforretning A/S
Skelbæk 12
4460 Snertinge
Tlf. 59 26 80 04
www.s-mf.com

Se www.danfoil.dk for komplet
forhandlerliste for Danmark.

Norge
AGRITEKNIKK AS
V/ Geir Arne Skyrud
Østgården
NO-2265 Namnå
Tlf. +47 46842610
geir@agriteknikk.no

Sverige
Håkan Svegrup
Reservelede/Service/Test
Vindbackagården
SE-241 92 Eslöv
Tlf. +46 (0)708924116
hs@danfoil.dk

Finland
Suomen Yrittäjien Maatalous OY
Alhoniituntie 4
FIN-01900 Nurmijärvi
Tlf. +358 92764 550
Fax. +358 92764 5555

Tyskland/Schweiz

Land und Baumaschinen Service AG
Brühlstrasse 7
CH-4107 Ettingen
Tlf. +41 61722 0655
Fax. +41 61722 0658
info@lubs.ch

Kontakt danfoil på
+45 98 67 42 33 eller
info@danfoil.dk

Estland
Starfeld OÜ
Aretuse 7
Märje Täthvere Vald
EE-61406 Tartumaa
Tlf. +372 (0)7346855
www.starfeld.ee

Litauen
Technikos tiekimo kompanija UAB
Azuolytes g. 2
LT-37176 Panevezys
Tlf. +370 61451213
www.ttk.lt

Øvrige Europa
Kontakt danfoil på
+45 98 67 42 33 eller
info@danfoil.dk

DK

Ret til ændringer i priser og specifikationer uden varsel forbeholdes. Ligeledes tages forbehold for trykfejl.
I øvrigt gælder almindelige salgs- og leveringsbetingelser for danfoil a/s.
Eftermontering af udstyr pålægges monteringsomkostninger.
Der tillægges et gebyr på 150,- kr. på ordre under netto 500,- kr.
Denne prisliste annullerer alle tidligere prislister og er gyldig fra 01.09.2013.
Priser i DKK, ab fabrik (Incoterms 2010), Excl. Moms

ENG

The company reserves the right to alter its prices and any specifications at any time.
The prices are based on present exchange rate.
Conditions of Sale are "General Conditions for Sales and Delivery for danfoil a/s.
Mounting of extra equipment after delivery will be charged
For orders below DKK 500,- a fee for DKK 150,- will be added
All previous lists cancelled. This price list is effective from 1st of September 2013.
Prices EXW (Incoterms 2010), exclude VAT and taxes.

Psc	Pos	Psc	Number	Name	Price	Note	
			Forside CCII 2 Forside CCII 2013 Options			1	
			60604660	GPS modem kit incl. antenne	2		
			60602016	Arbejdslys Hella LED - Til 2-delt bom	3		
			60602018	Arbejdslys Hella LED - Til 3-delt bom	4		
			60600006	Endedyser sæt for kpl. bom	5		
			90510396	LS-forstærker flow komplet kit	6		
			90510395	LS-forstærker tryk komplet kit	7		
			60602030	Elektronisk vindmåler	8		
			20602061	Fyldeflowmåler automatisk ECC II	9		
			HYD_XJS	Højtryksrenser	10		
			90105010	Mont.sæt f/traktor PC styring std.	11		
			60604525	160 AR Pumpe t/omrøring ECC II	12		
			60604536	Combi-udstyr f/Basis injec. ECC II	13		
			60601023	Hydraulisk platform f/inj tanke ECC II	15		
			60601060	Elektronisk styring af omrørerpumpe	16		
			60602020	Kemikalieskab	17		
			20203020	Flydende gødnings linje	18		
			60603005	Flydende gødning fra 150-300L/ha	19		
			60603000	Flydende gødning op t. 150L/ha	20		



Pos	Psc	Number	Name	Price	Note
1	1	90404660	GPS modem kit incl. antenne		

Side 2



Pos	Psc	Number	Name	Price	Note
1	1	90400176	Lygte Hella Power Beam 1500		
	10	90400037	Kabel 2x0.75 sort kappe		
2	1	90407513	2-pole connector female		
	1	90407514	for 2-pole female holder		
	2	90407524	female type		
	1	90320352	Slangeholder 20 mm enkelt grøn		



Pos	Psc	Number	Name	Price	Note
1	1	90400176	Lygte Hella Power Beam 1500		
	10	90400037	Kabel 2x0.75 sort kappe		
2	1	90407513	2-pole connector female		
	1	90407514	for 2-pole female holder		
	2	90407524	female type		

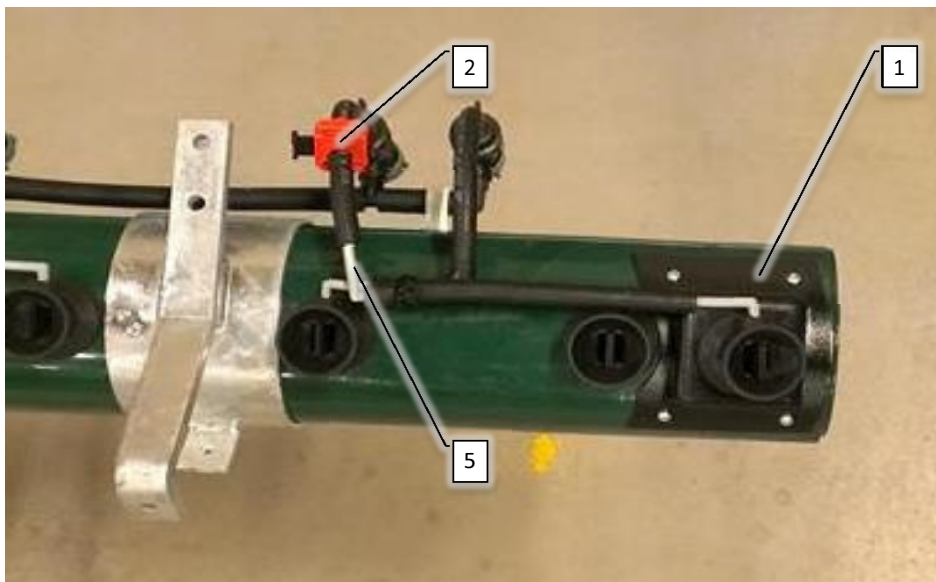
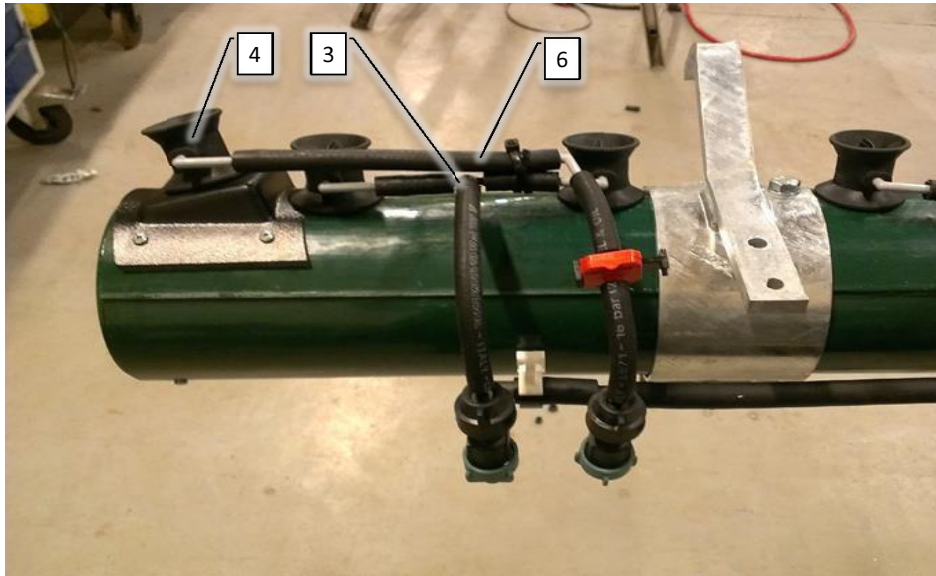

Pos	Psc	Number	Name	Price	Note
1	1	90320109	Endedyse, skærm		
2	1	90320099	Plasson minihane		
3	1	90326060	Drypstop 2011-> grøn db.		
4	1	90320083	Eurofoil forstøver kompl.		
5	1	90326015	Fordeler 2011-2014 grå/grå enk.		
6	0,25	90340001	Slange 6,3mm - tryk		

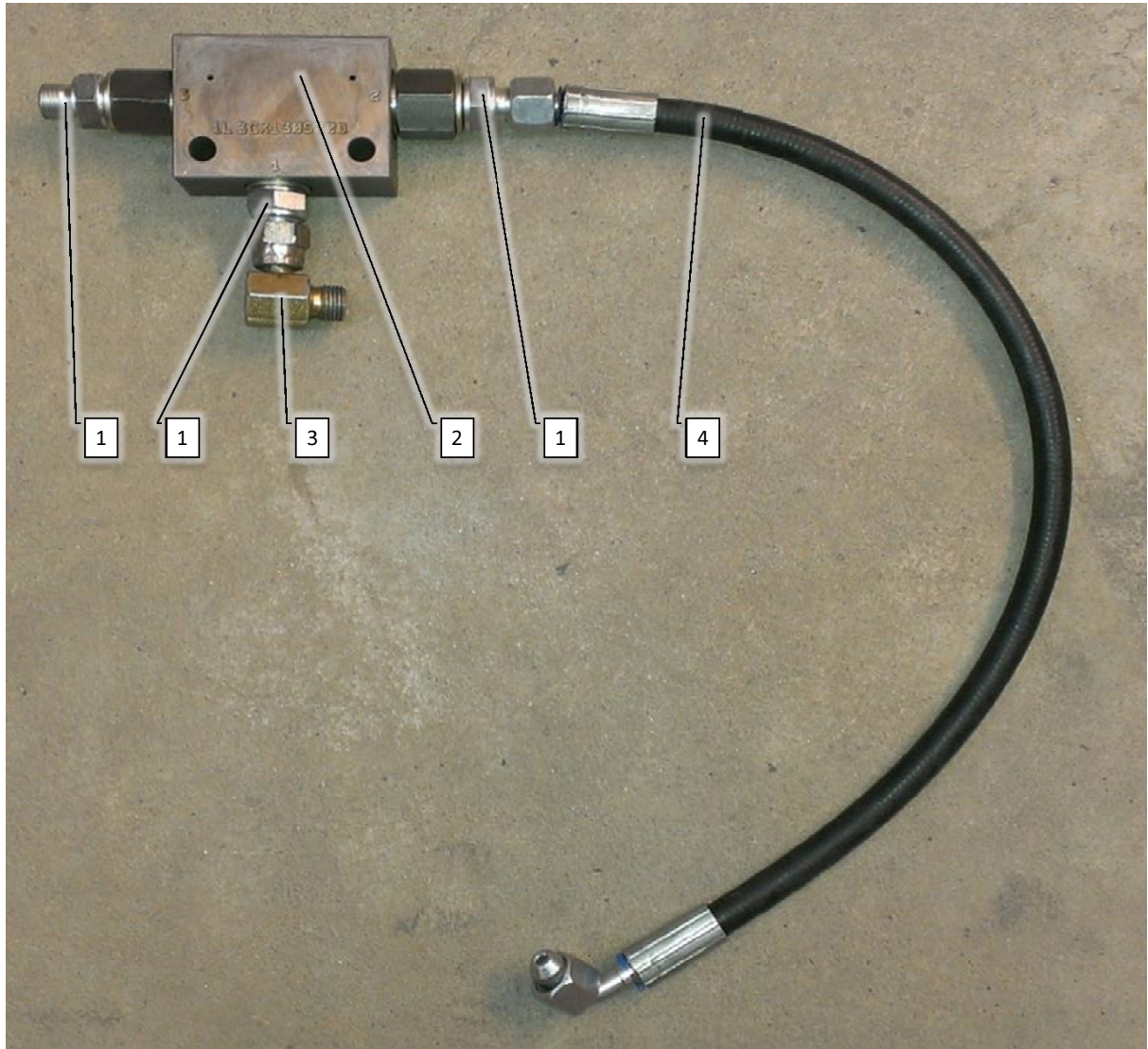

Pos	Psc	Number	Name	Price	Note
1	1	90510040	Hy brystnippel 1/4' x 1/4' BSP Male		
		90510055	Bonded seals hydr.1/4'		
2	1	90510212	LS forstærker Flow (158 H 805500)		
3	1	90510268	Hy nippel 1/4 m omløber		
		90510055	Bonded seals hydr.1/4'		
4	1	90510187	Hy slangekob 1/4 BSP F 1/4		
		90510280	Hylse 1/4 MF2000		
	0,6	90510246	Hy slange 1/4 løbende meter 1-lags		
	1	90510196	Hy slangekob 1/4 BSP F 90 1/4		

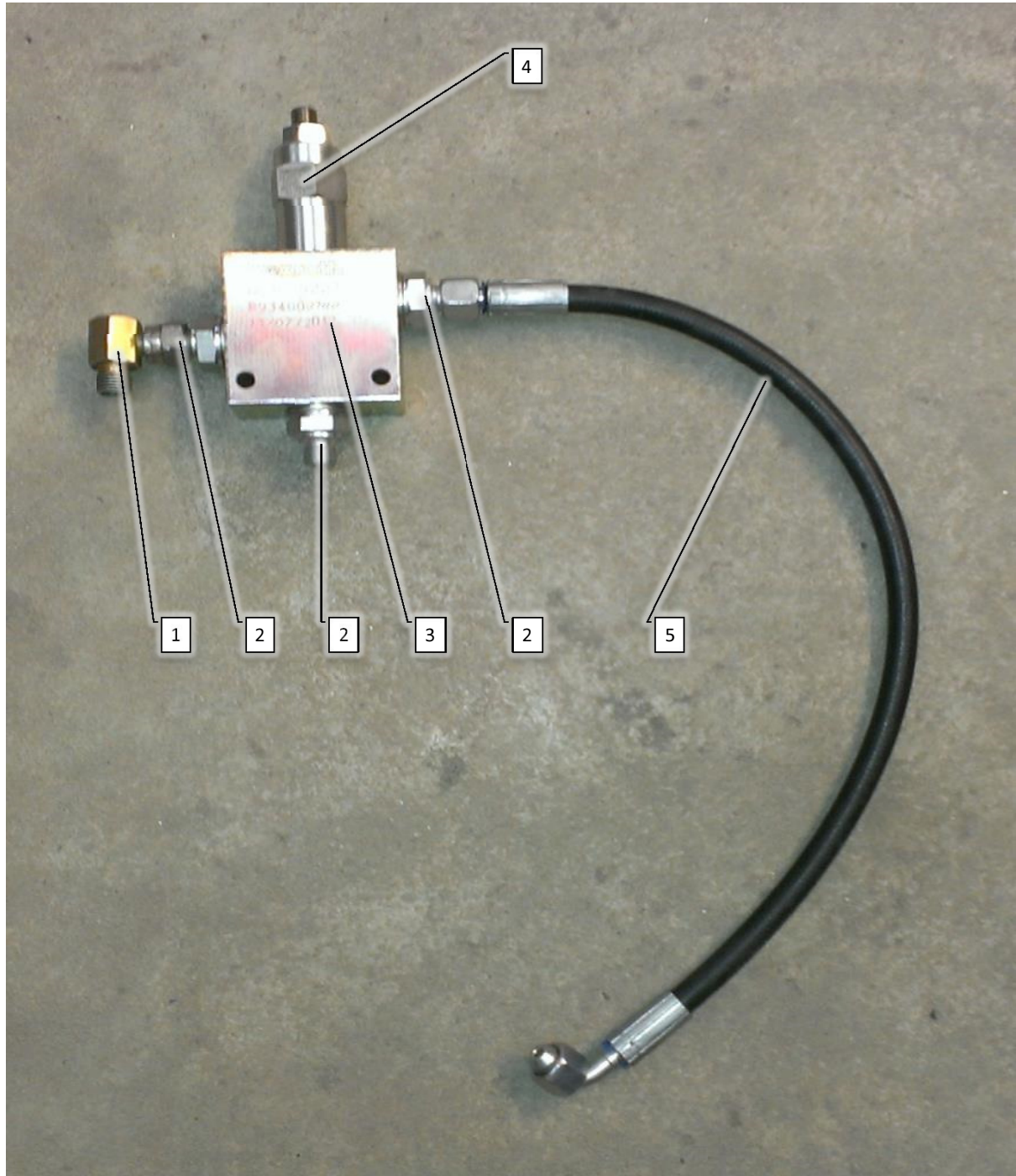

Pos	Psc	Number	Name	Price	Note
1	1	90510268	Hy nippel 1/4 m omløber		
	1	90510055	Bonded seals hydr.1/4'		
2	1	90510041	Hy brystnippel 1/4' x 3/8'		
	1	90510056	Bonded seal hydr. 3/8'		
3	1	90510072	Hy hus for LS forstærker tryk		
4	1	90510327	Patron t/LS forstærker tryk		
5	1	90510187	Hy slangekob 1/4 BSP F 1/4		
	2	90510280	Hylse 1/4 MF2000		
	0,6	90510246	Hy slange 1/4 løbende meter 1-lags		
	1	90510196	Hy slangekob 1/4 BSP F 90 1/4		



Pos	Psc	Number	Name	Price	Note
1	1	90400017	Vindmåler		
	1	90330463	Beslag f. elektronisk vindmåler		



Pos	Psc	Number	Name	Price	Note
1	1	1 90320503	Slangest. G1 1/4'x32mm ARAG		
		1 90320513	Omløber G1 1/4' ARAG		
2	1	90320264	Spidsmuffe G1 1/2'xG1 1/4' ARAG		
3	1	90334801	Konsol fylde flowmåler 95mm bred		
		90400013	Gevindstuds Ø 26x1 500udv g		
		90400016	Flowmåler Ø26 10m fyldeflowmål		
4	1	90400026	Motorventil t.fyldeflowmåler		
		90400161	Kabel f motorventil 6m		
5	1	90320453	Nippelreduktion G1 1/2'xG1 1/4' ARAG		
		90320513	Omløber G1 1/4' ARAG		
		90320531	Slangest. G1 1/4'x32mm 90G ARAG		

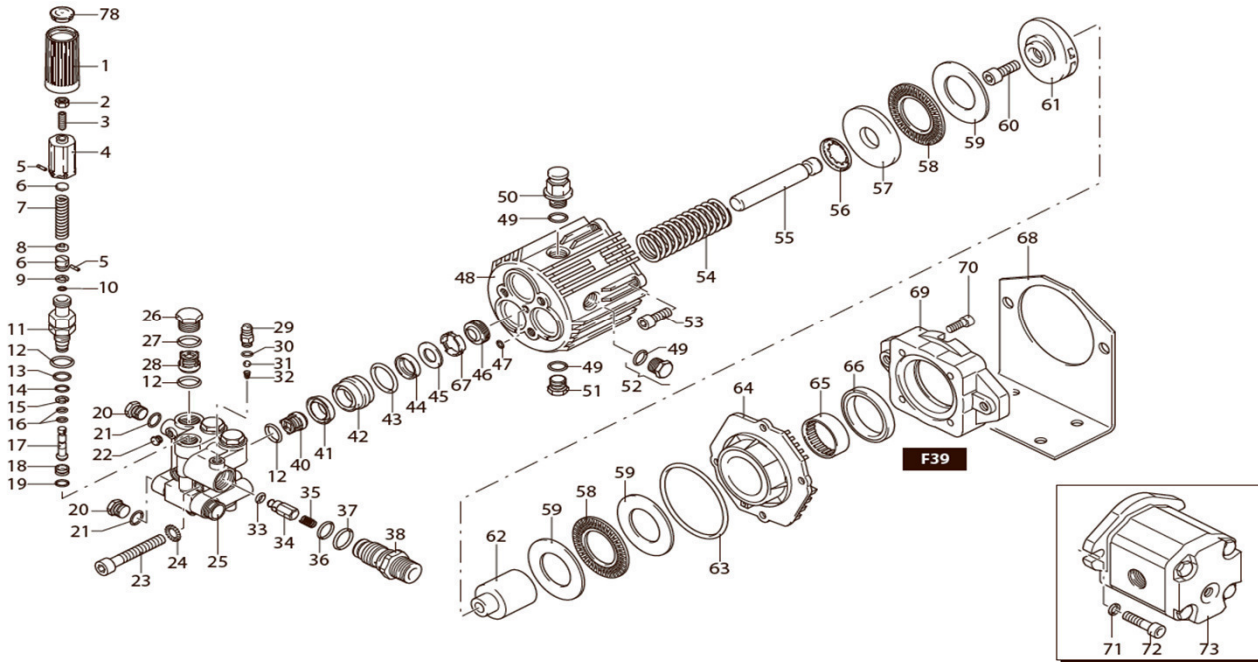

KIT RICAMBI / PART KITS

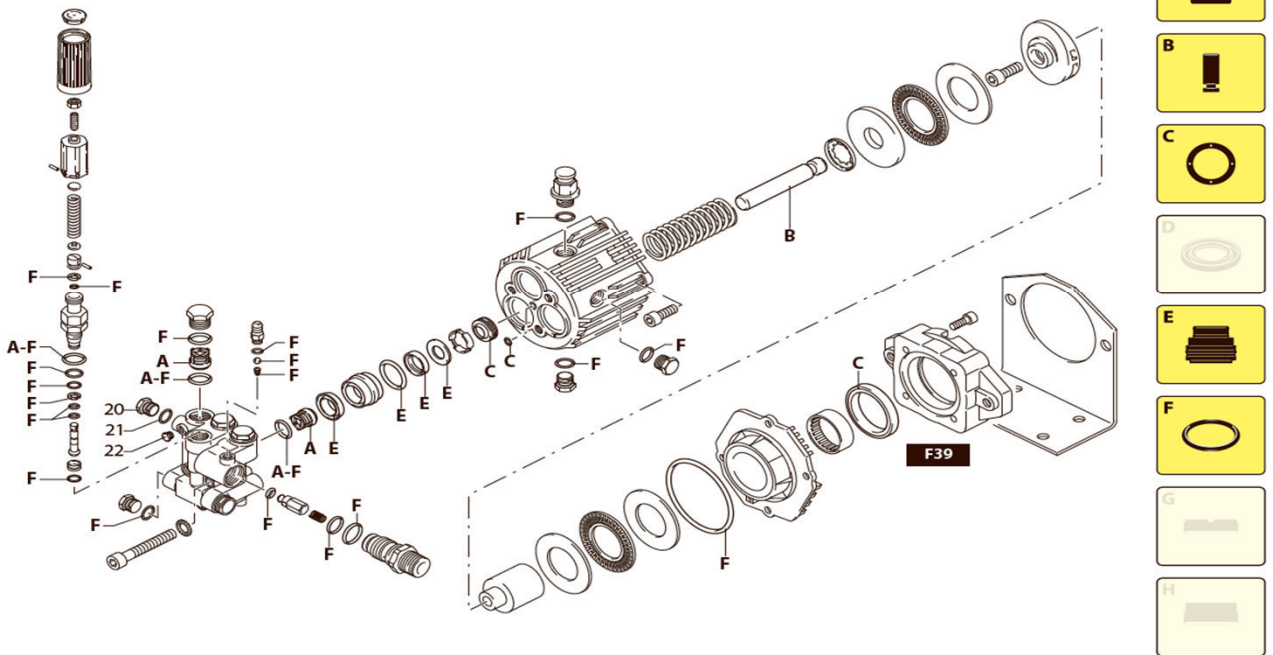

Pos	Psc	Number	Name	Price	Note
Top		90320171	Pumpe/motor højtryksrenser		
73		90320586	Hyd.motor t/højtryksrenser		
NA		90320585	Væskepumpe til højtryksrenser		
A		90327461	Ventilsæt f/højtryksrenser		
C		90327460	Olie Pak. sæt for højtryksrenser		
E		90320174	Væske Pak. sæt f. højtryksrenserpumpe		
NA		90320075	Muffe 1/4 t/højtryksrenser		
NA		90320170	Slangerulle for højtryksrenser 15 m		
NA		90325057	Pistolgreb højtryksrenser		
NA		90325072	Lance f. pistolgreb højtryksrenser		
NA		90330560	Mont.beslag højtryksrenser AB		
NA		90520048	Dyse t. højtryksrenser		



Pos	Psc	Number	Name	Price	Note
1	1	1 90105010	Mont.sæt f/traktor PC styring std.		
		1 90320513	Omløber G1 1/4' ARAG		
	2	1 90320264	Spidsmuffe G1 1/2'xG1 1/4' ARAG		
	3	1 90334801	Konsol fylde flowmåler 95mm bred		
		1 90400013	Gevindstuds Ø 26x1 500udv g		
		1 90400016	Flowmåler Ø26 10m fyldeflowmål		
	4	1 90400026	Motorventil t.fyldeflowmåler		
		1 90400161	Kabel f motorventil 6m		
	1	1 90320453	Nippelreduktion G1 1/2'xG1 1/4' ARAG		
		2 90320513	Omløber G1 1/4' ARAG		
		1 90320531	Slangest. G1 1/4'x32mm 90G ARAG		

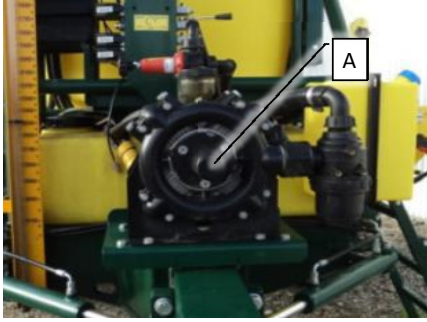

Pos	Psc	Number	Name	Price	Not Note
1	A	1 30300110	Væskepumpesystem Std. CC II		
		1 90510052	PVMR32 m/friktionslås gl		
		1 90510053	PVM32 Mekanisk aktivering		
		4 90510057	Bonded seal hydr.1/2'		
		1 90510211	PVG 32 basismodul m/comp		
		1 90510265	PVG stagbolte sæt 5 sek med pak		
		1 90510277	Flange for SAE-A m/ø25mm ar 160/185		
		1 90510288	Glider 15L manuel (f. PVG væske pumpe)		
		1 90510326	Tap t/glider for PVBS ventil		
		2 90515120	Hy slange CCII 3/8" væskepumpe 1200mm		

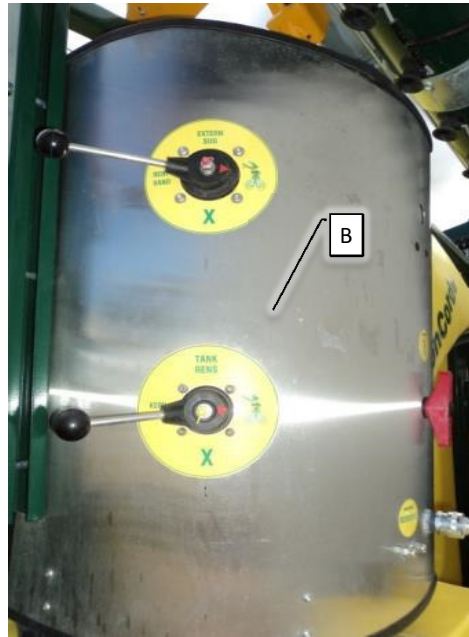
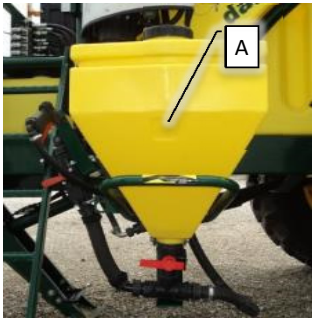

Pos	Psc	Number	Name	Price	Not Note
1	1	90330366	Sidebue CC		
A	1	30300029	Kemifylder klargjort CC II		
B	1	30300812	Betjeningspanel Inj.Combi CC II		
C	1	30300110	Væskepumpesystem Std. CC II		

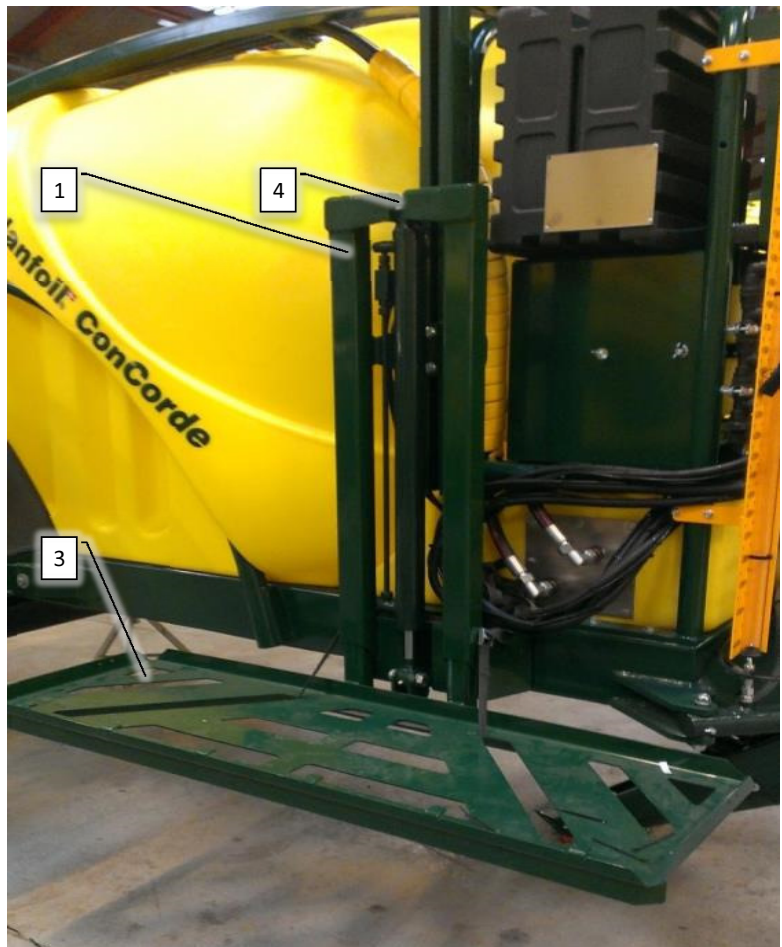

Pos	Psc	Number	Name	Price	Note
1	1	90330297	Kemiholder CC II		
	5	90210034	Bolt M10x30 FZB 8.8 ubryst		
	1	90330398	Laskeplade stor CC		
	2	90210041	Bolt M12x45 FZB 8.8 ubryst		
	2	90210056	Møtrik M12 FZB låse		
2	1	90510610	Cylinder t. kemiplatform CC II		
	2	90515077	Hy slange AB CCII 1/4' LS 1600mm		
	2	90510041	Hy brystnippel 1/4' x 3/8'		
	2	90510233	Hy nippel 1/4x1/2 BSP M/M		
	2	90510056	Bonded seal hydr. 3/8'		
	2	90510057	Bonded seal hydr.1/2'		
3	1	90330296	Platform f. kemikaliedunke AC 6000		
4	2	90210022	Bolt M20x70 FZB 8.8 ubryst		
	2	90210069	Møtrik M20 FZB låse		
	4	90210077	Skive M20 FZB Facet		
5	1	90330308	Båndsuringsæt 3 m- 25mm sort		



Pos	Psc	Number	Name	Price	Not Note
1	1	90400086	Trykknop Start		
	5	90400037	Kabel 2x0.75 sort kappe		
2	1	20200204	PVG modul 4		



Pos	Psc	Number	Name	Price	Note
1	1	1 90105010	Mont.sæt f/traktor PC styring std.		
		1 90320513	Omløber G1 1/4' ARAG		
2	1	1 90320264	Spidsmuffe G1 1/2'xG1 1/4' ARAG		
3	1	1 90334801	Konsol fylde flowmåler 95mm bred		
		1 90400013	Gevindstuds Ø 26x1 500udv g		
		1 90400016	Flowmåler Ø26 10m fyldeflowmål		
4	1	1 90400026	Motorventil t.fyldeflowmåler		
		1 90400161	Kabel f motorventil 6m		
1	1	1 90320453	Nippelreduktion G1 1/2'xG1 1/4' ARAG		
		2 90320513	Omløber G1 1/4' ARAG		
		1 90320531	Slangest. G1 1/4'x32mm 90G ARAG		

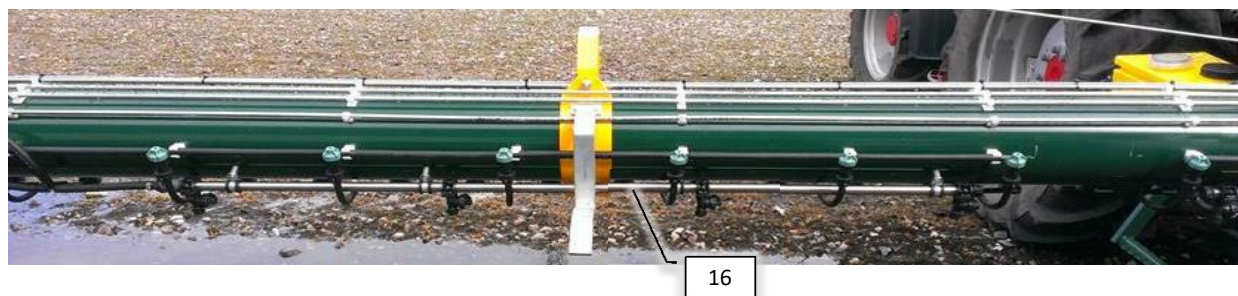
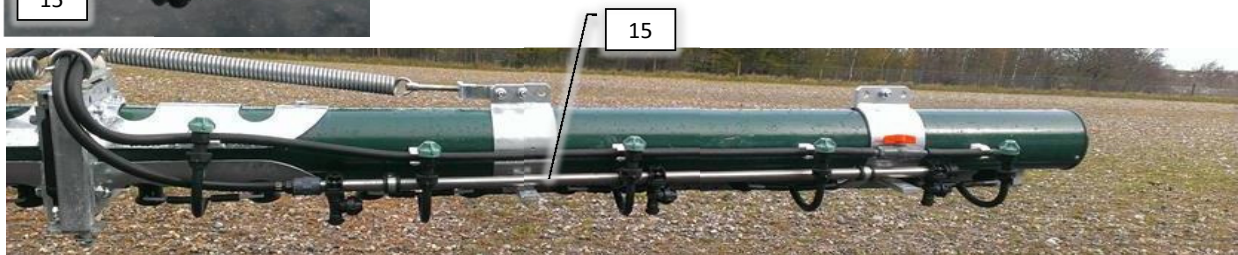
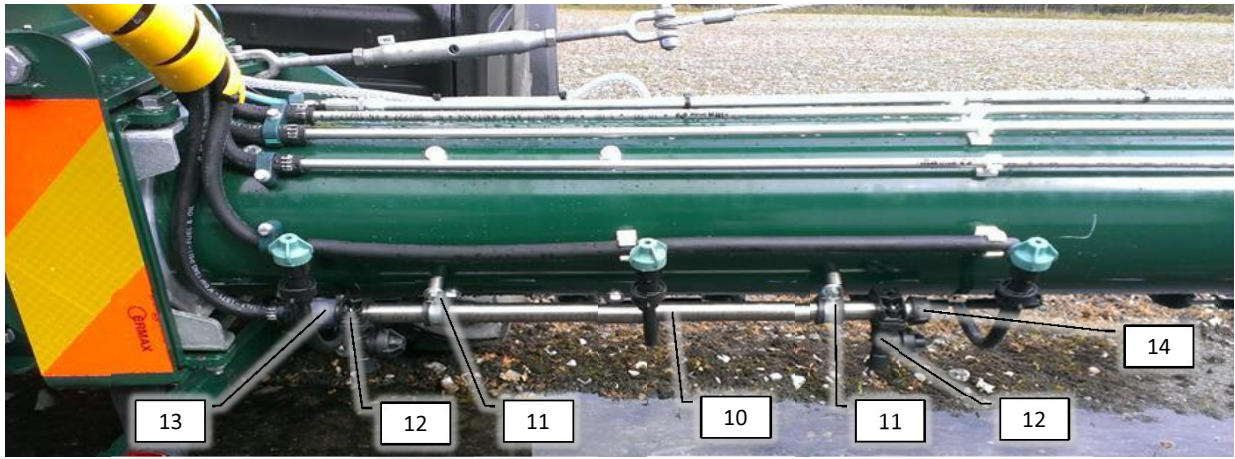
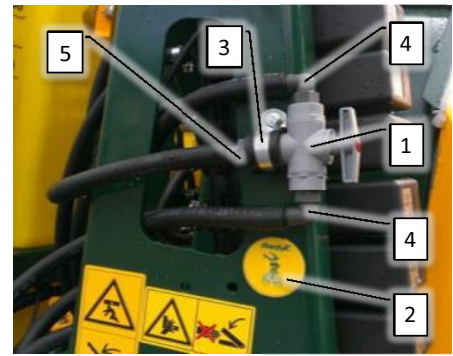
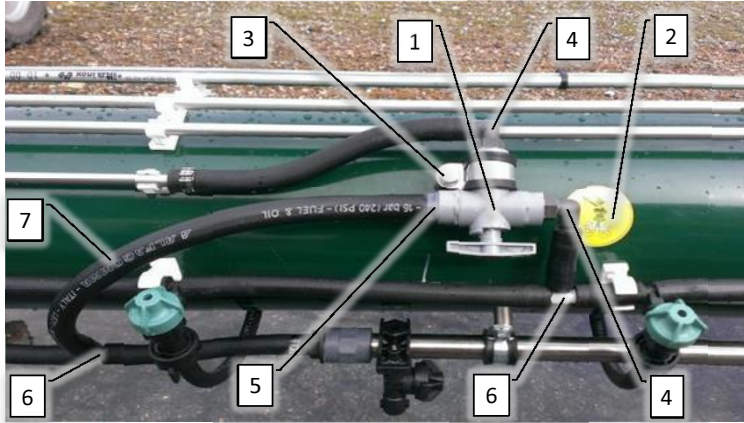

Pos	Psc	Number	Name	Price	Not Note
1	1	90320273	Kuglehane 3/8' 3-vejs		
2	1	90900065	Mærkat - filter/foil AB/CC		
3	1	90215017	Clamps 25 mm. 25/20		
	1	90330288	Bøsning Ø14x2x20 A2		
	1	90210006	Bolt M6x50 FZB 8.8 ubryst		
	1	90214405	Skive M6 FZB Facet		
	1	90210106	Jacknut 11.2 M6-LN		
4	2	90320199	Slangeforsk.3/8"x10x90°Norma		
5	1	90320286	Slangeforsk.3/8"x10mm		
6	1	90320243	T-slangestuds 10-10-10mm/TS 10		
7	1	90340019	Slange 10 mm - tryk		
10	1	90327536	Gødningsrør 57x2 stål		
11	2	90215013	Clamps 20 mm 20/20		
	2	90330288	Bøsning Ø14x2x20 A2		
	2	90210020	Bolt M6x40 FZB 8.8 ubryst		
	2	90214405	Skive M6 FZB Facet		
	2	90210106	Jacknut 11.2 M6-LN		
12	2	90327541	Gødningsholder t. dyser		
13	1	90320258	Muffe G1/2' ARAG		
	1	90320652	Slangeforsk. G1/2'x10mm ARAG		
	1	90210237	Slangeklemme Cobra 17/8 W4		
14	1	90320081	Låg G1/2'		
10	1	90327537	Gødningsrør 107x3 stål		
11	3	90215013	Clamps 20 mm 20/20		
	3	90330288	Bøsning Ø14x2x20 A2		
	3	90210020	Bolt M6x40 FZB 8.8 ubryst		
	3	90214405	Skive M6 FZB Facet		
	3	90210106	Jacknut 11.2 M6-LN		
12	3	90327541	Gødningsholder t. dyser		
13	1	90320258	Muffe G1/2' ARAG		
	1	90320652	Slangeforsk. G1/2'x10mm ARAG		
	1	90210237	Slangeklemme Cobra 17/8 W4		
14	1	90320081	Låg G1/2'		
16	1	90327538	Gødningsrør 157x4 stål		
11	4	90215013	Clamps 20 mm 20/20		
	4	90330288	Bøsning Ø14x2x20 A2		
	4	90210020	Bolt M6x40 FZB 8.8 ubryst		
	4	90214405	Skive M6 FZB Facet		
	4	90210106	Jacknut 11.2 M6-LN		
12	4	90327541	Gødningsholder t. dyser		
13	1	90320258	Muffe G1/2' ARAG		
	1	90320652	Slangeforsk. G1/2'x10mm ARAG		
	1	90210237	Slangeklemme Cobra 17/8 W4		
14	1	90320081	Låg G1/2'		
15	1	90320146	Vinkel G1/2' 90G F-F ARAG		
	1	90320652	Slangeforsk. G1/2'x10mm ARAG		
	1	90210237	Slangeklemme Cobra 17/8 W4		
	1	90320081	Låg G1/2'		



Pos	Psc	Number	Name	Price	Not Note
A	1	20203020	Flydende gødnings linje		



Pos	Psc	Number	Name	Price	Not Note
A	1	20203020	Flydende gødnings linje		

danfoil[®]

Jellingvej 14 | DK-9230 Svenstrup J

Tlf. +45 98 67 42 33

www.danfoil.dk | info@danfoil.dk

