



Spare Parts Catalogue
danfoil ConCorde II

MultiDose Injection

danfoil®
- less is more...



Hovednummer:
+45 98 67 42 33

Vagttелефон: (april til oktober):
+45 40 43 12 33

Fax:
+45 98 67 34 88

E-mail:
info@danfoil.dk

Adresse:
danfoil a/s
Jellingvej 14
DK-9230 Svenstrup
www.danfoil.dk

Servicepartner
TBS Maskinpower A/S
Ørderup Kirkevej 43
6520 Tofthund
Tlf. 75 38 11 22
www.tbs.dk

Snertinge Maskinforretning A/S
Skelbæk 12
4460 Snertinge
Tlf. 59 26 80 04
www.s-mf.com

Se www.danfoil.dk for komplet
forhandlerliste for Danmark.

Norge
AGRITEKNIKK AS
V/ Geir Arne Skyrud
Østgården
NO-2265 Namnå
Tlf. +47 46842610
geir@agriteknikk.no

Sverige
Håkan Svegrup
Reservelede/Service/Test
Vindbackgården
SE-241 92 Eslöv
Tlf. +46 (0)708924116
hs@danfoil.dk

Finland
Suomen Yrittäjien Maatalous OY
Alhoniituntie 4
FIN-01900 Nurmijärvi
Tlf. +358 92764 550
Fax. +358 92764 5555

Tyskland/Schweiz

Land und Baumaschinen Service AG
Brühlstrasse 7
CH-4107 Ettingen
Tlf. +41 61722 0655
Fax. +41 61722 0658
info@lubs.ch

Kontakt danfoil på
+45 98 67 42 33 eller
info@danfoil.dk

Estland
Starfeld OÜ
Aretuse 7
Märje Täthvere Vald
EE-61406 Tartumaa
Tlf. +372 (0)7346855
www.starfeld.ee

Litauen
Technikos tiekimo kompanija UAB
Azuolytes g. 2
LT-37176 Panevezys
Tlf. +370 61451213
www.ttk.lt

Øvrige Europa
Kontakt danfoil på
+45 98 67 42 33 eller
info@danfoil.dk

DK

Ret til ændringer i priser og specifikationer uden varsel forbeholdes. Ligeledes tages forbehold for trykfejl.
I øvrigt gælder almindelige salgs- og leveringsbetingelser for danfoil a/s.
Eftermontering af udstyr pålægges monteringsomkostninger.
Der tillægges et gebyr på 150,- kr. på ordre under netto 500,-kr.
Denne prisliste annullerer alle tidligere prislister og er gældig fra 01.09.2013.
Priser i DKK, ab fabrik (Incoterms 2010), Excl. Moms

ENG

The company reserves the right to alter its prices and any specifications at any time.
The prices are based on present exchange rate.
Conditions of Sale are "General Conditions for Sales and Delivery" for danfoil a/s.
Mounting of extra equipment after delivery will be charged
For orders below DKK 500,- a fee for DKK 150,- will be added
All previous lists cancelled. This price list is effective from 1st of September 2013.
Prices EXW (Incoterms 2010), exclude VAT and taxes.

Psc	Pos	Psc	Number	Name	Price	Note
				Forside CCII 2013 Inj.		1
			30300103	Basis Inj. CC II		2
			20200053	Hovedramme komplet CCII		3
			30300108	Hjulaksel komplet CC II		4
			20200054	Støtteben kpl. CC II		5
			20200060	Træk kpl. CC II		6
			20200059	Hjulskærme klp. CC II		7
			30300113	Lygtesæt klp. CC II		8
			20200057	Hydraulikkomponenter CCI		9
			30300027	Tank 3000L montage CC II		10
			30300026	Tankmåler kpl. CC II		11
			30300120	Rentvandstank inj. CC II		12
			30300126	Væskepumpemodul Inj. CC II		13
			30300135	Tank 3000L ekstra til inj. CCII		14
			20200062	Styring basis inj. CC II		15
			20200066	Mærkater basis CC II		16
			20200175	Sæbetank 15l Concorde		17
			20200058	Stige kpl. CC II		18
			20200063	Rørholdersæt basis inj. CC II		19
			20200160	Injectionsskab basis		20
			30300162	Manifold injektion CCII		21
			20200130	Rensesystem		22
			20200150	Tilkoblingsstuds til rensesystem		23
			60604115	Tilkoblingsstuds expander til rensesyst		24
			90510320	Slangesæt kpl. CC II		25
			30300105	Luftfordeler klargjort 20-28m ECC I		26
			30300099	Luftfordeler klargjort >28-36m ECC I		27
			30300115	Bagende 2-delt bom ECC II		28
			30300122	Bagende 3-delt bom ECC II		29
			30300136	Sek.-ventiler 7 sek. inj. 20-30m ECC I		30
			30300128	Sek.-ventiler 9 sek. inj. >30-36m ECC I		31
			90326060	Drypstop dobb. kpl. 2011		32
			90326055	Drypstop Højre enkelt 2011		33
			90326014	Fordeler db. sort/grå 2011-2014		34
			90326015	Fordeler enk. grå/grå 2011-2014		35
			90320083	Eurofoil forstøver kompl.		36
			60604131	Injection system til 1 pumpe		37
			60604132	Injection system til 2 pumper		38
			60604133	Injection system til 3 pumper		39
			60604134	Injection system til 4 pumper		40
			60604135	Injection system til 5 pumper		41
			60604136	Injection system til 6 pumper		42
			60604058	Injections pumpe lille		43
			60604057	Injections pumpe stor		44
			60604059	Injektionspumpe basis		45
			90105011	Mont.sæt f/traktor PC styring INJ.		46
			60601027	Standard Platform f/ inj. tanke ECC II		47
			20200090	Omrøring AB CC		48
			30300812	Betjeningspanel Inj.Combi CC II		49
			90330308	Båndsurringssæt 3 m- 25mm sort		50
			20200052	Dele f. montering på traktor inj. AB-CC		51

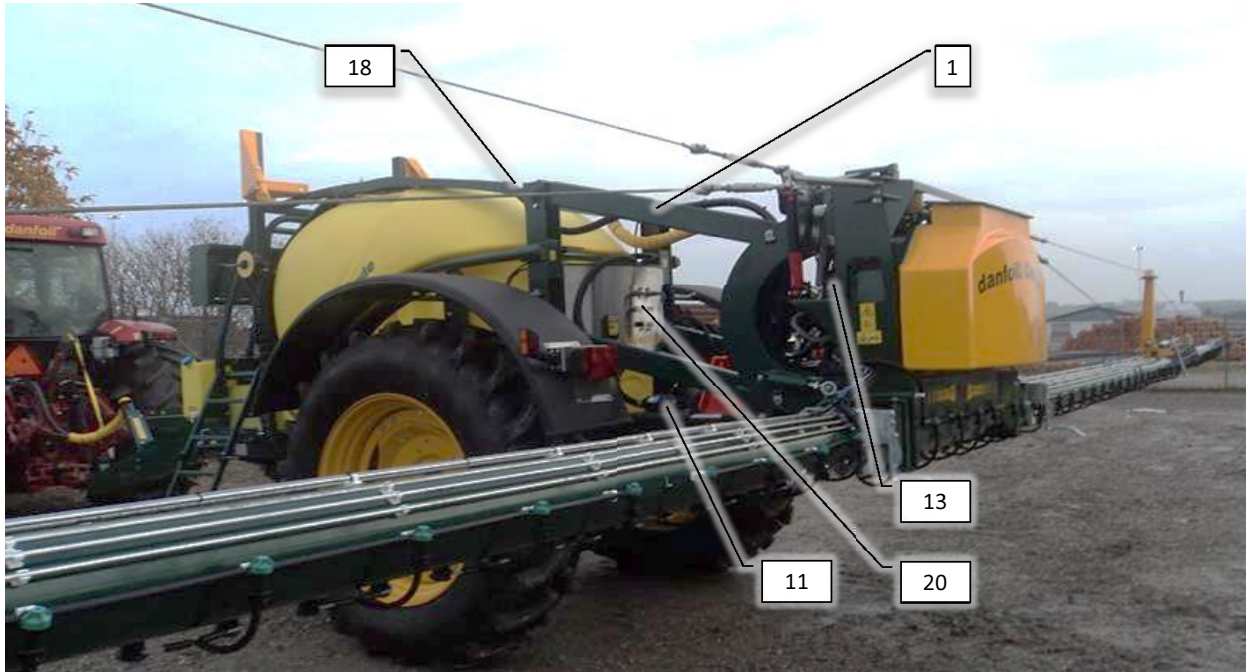
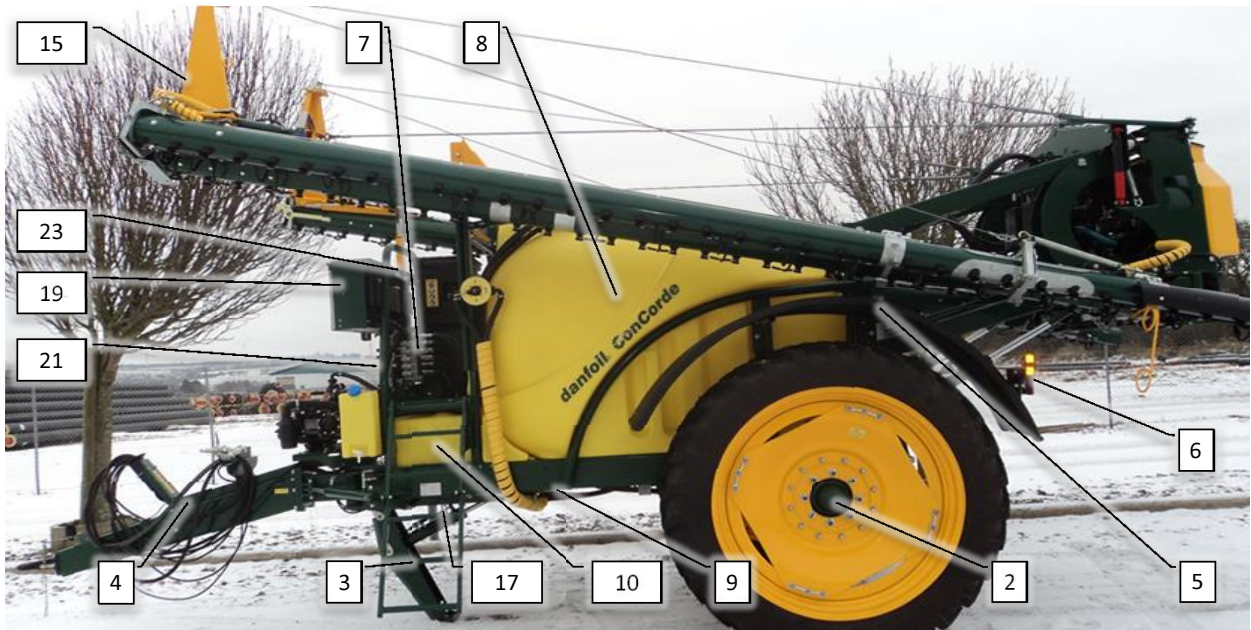

Pos	Psc	Number	Name	Price	Note
1	1	20200053	Hovedramme komplet CCII		
2	1	30300108	Hjulaksel komplet CC II		
3	1	20200054	Støtteben kpl. CC II		
4	1	20200060	Træk kpl. CC II		
5	1	20200059	Hjulskærme klp. CC II		
6	1	30300113	Lygtesæt klp. CC II		
7	1	20200057	Hydraulikkomponenter CCI		
8	1	30300027	Tank 3000L montage CC II		
9	1	30300135	Tank 3000L ekstra til inj. CCII		
10	1	30300120	Rentvandstank inj. CC II		
11	1	30300126	Væskepumpemodul Inj. CC II		
12	1	30300026	Tankmåler kpl. CC II		
13	1	20200062	Styring basis inj. CC II		
15	1	20200066	Mærkater basis CC II		
16	1	20200175	Sæbetank 15l Concorde		
17	1	20200058	Stige kpl. CC II		
18	1	20200063	Rørholdersæt basis inj. CC II		
19	1	20200160	Injectionsskab basis		
20	1	30300162	Manifold injektion CCII		
21	1	20200130	Rensesystem		
22	1	20200150	Tilkoblingsstuds til rensesystem		
23	1	90330507	Holder for skab		
	1	90403411	Skab for værktøj lille model CC II		
	1	90330508	Bagplade		
	2	90401504	Håndtag/greb til platform CC DE		
	4	90210002	Bolt M6x20 FZB 8.8 ubrust		

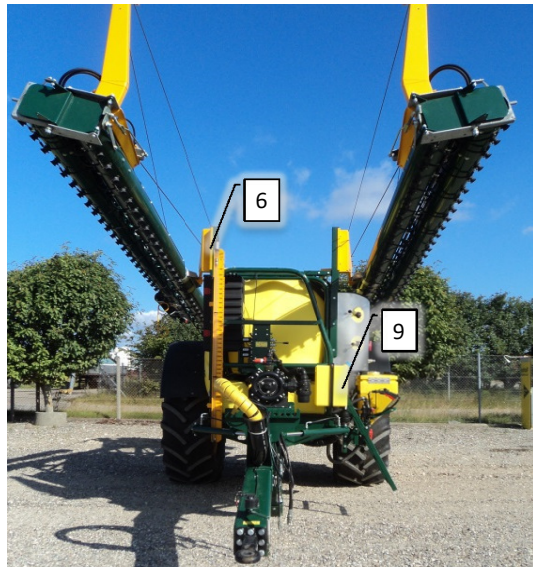
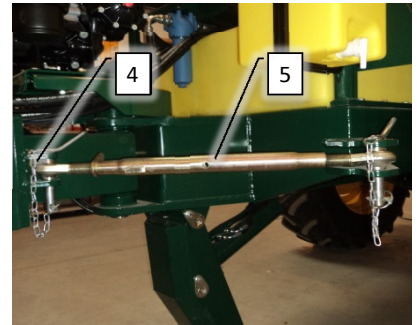
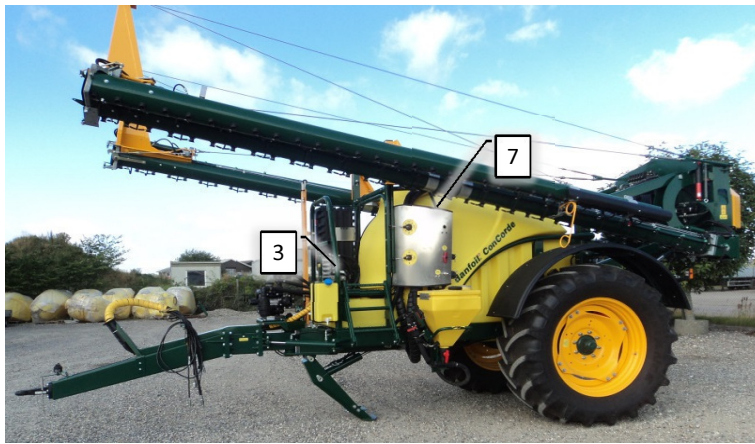
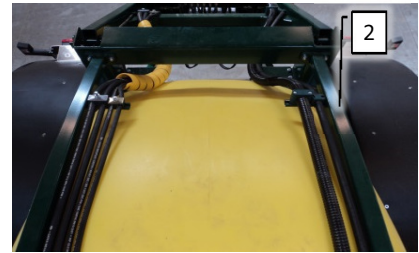
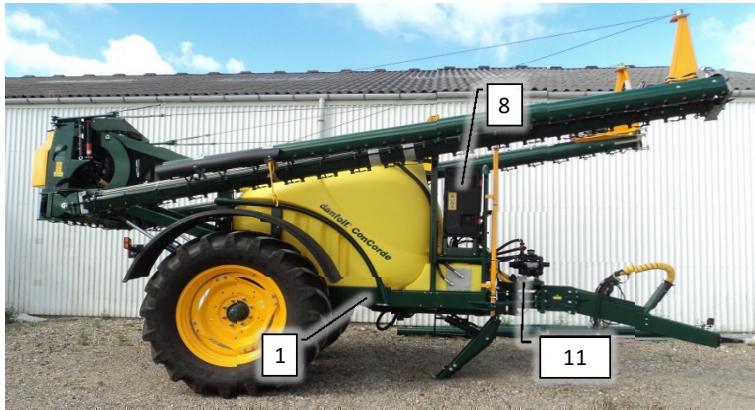

Pos	Psc	Number	Name	Price	Note
1	1	90330348	Hovedramme CCII		
	1	90330368	Befæstelse til tank CC		
	1	90330370	Vinkelanlæg CC		
2	1	90330364	Topstiver H CC		
	1	90330365	Topstiver V CC		
3	1	90330378	Platform CC		
	1	90330379	Bundplade CC		
4	1	90330486	Trækkonsol CC II		
	2	90210134	Messingbøsning til træk CC		
	1	90330371	Træknagle CC		
	2	90320548	Låsering til træknagle		
5	2	90330043	Topstang f. træk		
	4	90330010	Pig for A ramme/træk CC 25x130mm		
6	1	90336430	Bærekonsol venstre til CC		
	1	90336435	Bærekonsol højre til CC		
	2	90336409	Spændeplade til bærekonsol CC		
	1	90336440	Bærearm venstre til bærekonsol CC		
	1	90336445	Bærearm højre til bærekonsol CC		
7	1	90330366	Sidebue CC		
8	1	60604053	Plade f. magnetlabels		
9	1	90320368	Vandtank 15 l komplet Gul		
10	1	90400096	Trekantrefleks		
	1	90336940	Holder f/advarselstrekant		
	2	90320801	Prop 40x40		
	2	90320803	Prop 60x4,5		
	2	90320807	Prop 70x70x3-€		
	2	90320808	Prop 30x30x5		
11	1	90336938	Plade for pumpe std. CC II		

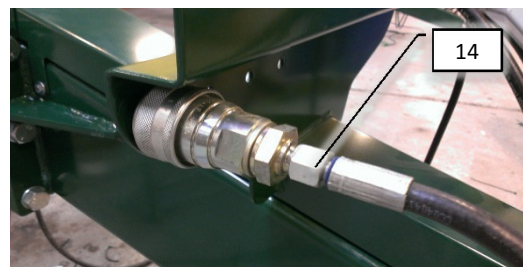
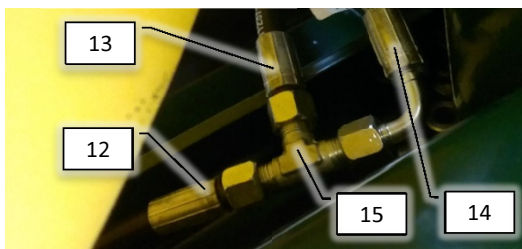
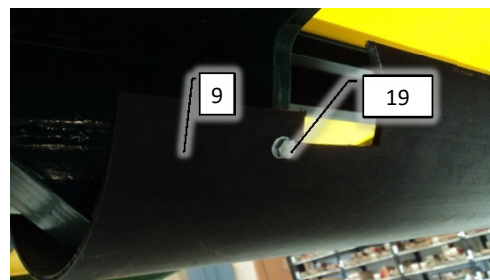
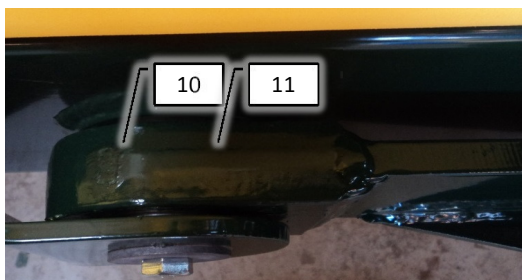
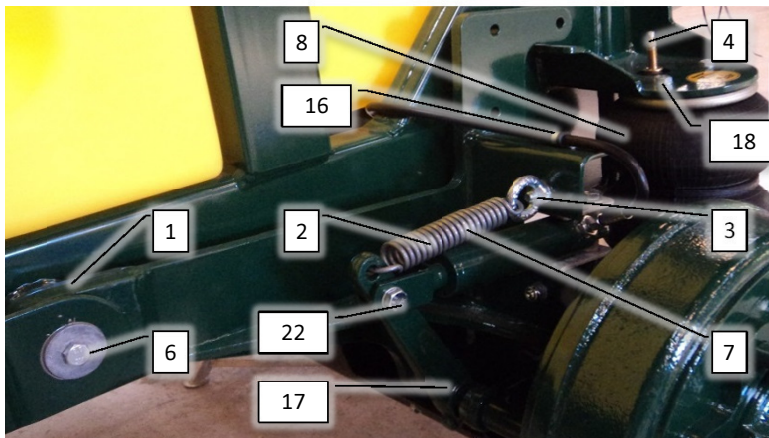
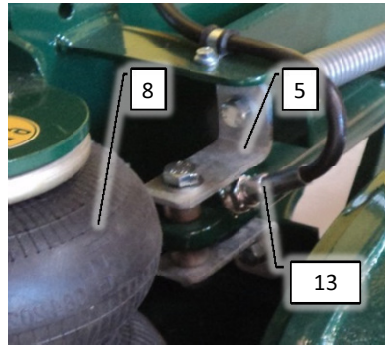
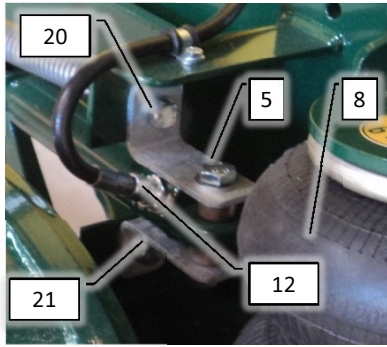

Pos	Psc	Number	Name	Price	Note
1	1	90330471	Hjulophæng combi m. luft afjd.		
2	1	90310051	Fjeder f.lås kemikaliefylder		
3	1	90210201	Øje/ringmøtrik 12mm el-galv		
4	1	90330493	Ventil t/luftpude affjdr. CC II		
5	2	90330109	Beslag f. bremsecylinder CC		
	2	90210344	Bolt M14x90 FZB 8.8 bryst		
	8	90214424	Skive M14 FZB Facet		
	2	90215002	Møtrik M14 FZB Låse		
6	2	90210133	Skive M14 Galv 14x50x4 CC		
7	1	90510078	Cylinder bremse CC 25x70 m. bremse		
8	1	90330484	luftpude t/affjdr. CC II		
9	1	90330075	Plastskærm for aksel CC		
10	2	90330289	Afstandsrør v. Hjulophæng Ø48,3x3,25x7		
11	1	90336015	Nagle for hjulophæng CC		
12	1	90515177	Hy slange CCII Bremseslange 1700mm		
	1	90510041	Hy brystnippel 1/4' x 3/8		
	2	90510056	Bonded seal hydr. 3/8		
13	1	90515176	Hy slange CCII Bremseslange 900mm		
	1	90510041	Hy brystnippel 1/4' x 3/8		
14	1	90515047	Hy slange CCII bremseslange 7000 mm		
	1	90510233	Hy nippel 1/4x1/2 BSP M/M		
	1	90320380	Lynkopling f. bremsei		
	1	90510057	Bonded seal hydr.1/2		
15	1	90510046	Hy T-stykke 1/4' BSP		
16	1	90215033	Clamps 12mm 12/15		
17	2	90210206	Bolt M10x60 FZB 8.8 bryst		
	2	90210055	Møtrik M10 FZB låse		
18	8	90210034	Bolt M10x30 FZB 8.8 ubryst		
	8	90210332	Skive M10 FZV 10,5x30x3		
19	4	90210011	Bolt M8x20 FZB 8.8 ubryst		
	4	90210084	Skive M8 8,4x25x2 Plan		
20	2	90210039	Bolt M12x50 FZB 8.8 ubryst		
	2	90214408	Skive M12 FZB Facet		
21	2	90210005	Bolt M12x35 FZB 8.8 ubryst		
	4	90214408	Skive M12 FZB Facet		
22	2	90210005	Bolt M12x35 FZB 8.8 ubryst		
	2	90210056	Møtrik M12 FZB låse		
	4	90214408	Skive M12 FZB Facet		

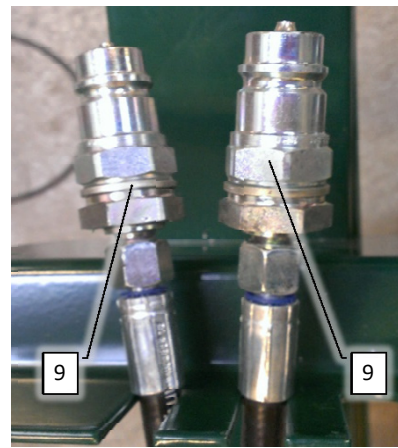
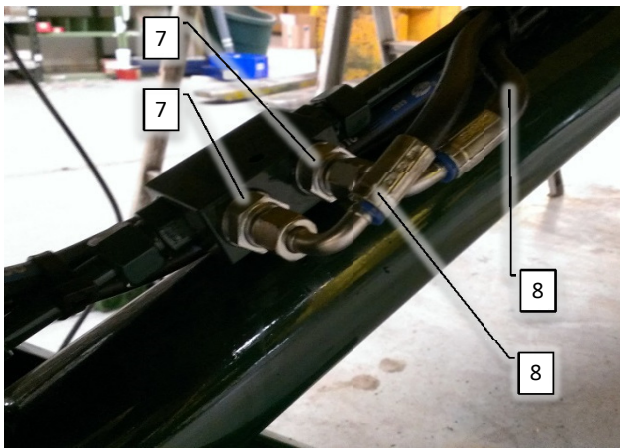
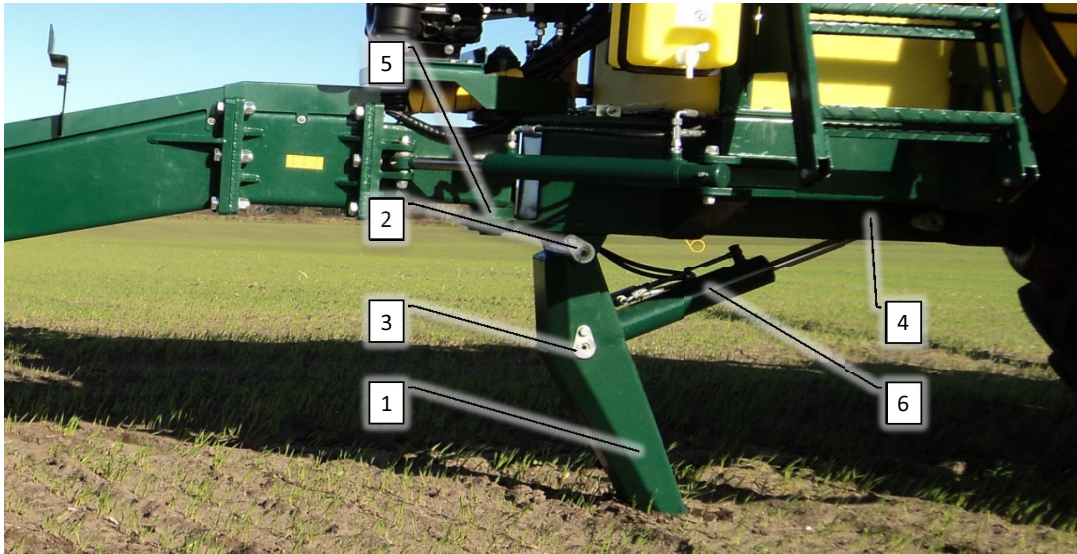

Pos	Psc	Number	Name	Price	Note
1	1	90330491	Støtteben CC II		
2	1	90330487	Nagle f/støtteben CC II 247,5mm		
3	1	90330488	Nagle f/støtteben CC II 200mm		
4	1	90330498	Nagle f/støtteben CCII 400 mm		
5	1	90320190	Slangeholder 12mm dobbelt grør		
6	1	90510360	Cylinder Støtteben CCII opmontere		
7	2	90510041	Hy brystnippel 1/4' x 3/8		
8	1	90515076	Hy slange AB CCII 1/4'bom 4700mm		
9	1	90510032	Lynkobling 1/2' har		
	1	90510043	Hy brystnippel 3/8'x1/2		

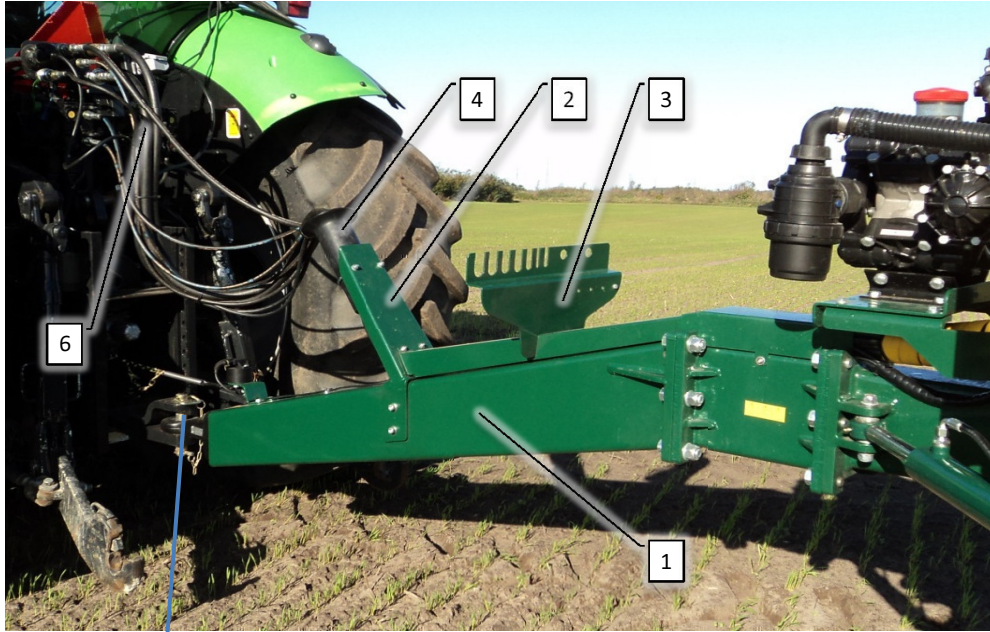

Pos	Psc	Number	Name	Price	Note
1	1	90330485	Træk CC II		
2	1	90330343	Slangeåg m/skjold CC II		
3	1	90330344	Konsol t/slangeføring træk CC I		
4	1	90330496	Tragt for hydraulikslanger/træk CCI		
		1 90215011	Udstødningsclamps 89 mm		
5	1	90330550	Øjetræk m/flange Ø50 (100-110mm) M16		
		1 90330201	Bøsning for træk 30/50 CC I		
6	1	90214081	Båndsurring 1 m - 25 mm gul		
		1 90100013	Slangebeskyttelse Ø75mm gul		

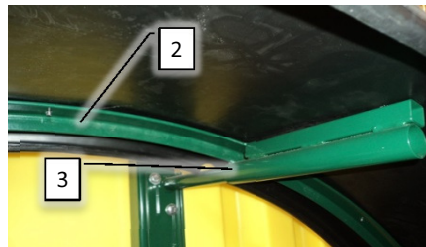

Pos	Psc	Number	Name	Price	Note
1	1	90330239	Hjulskærm for CC		
2	1	90330473	Skærmbeslag (valset) CC		
3	2	90330387	Skærmbeslag venstre CC		
	2	90330423	Skærmbeslag højre CC		

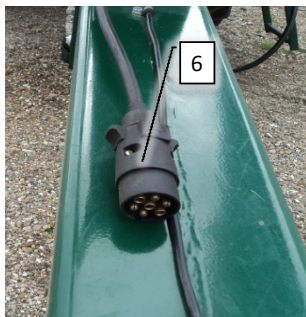
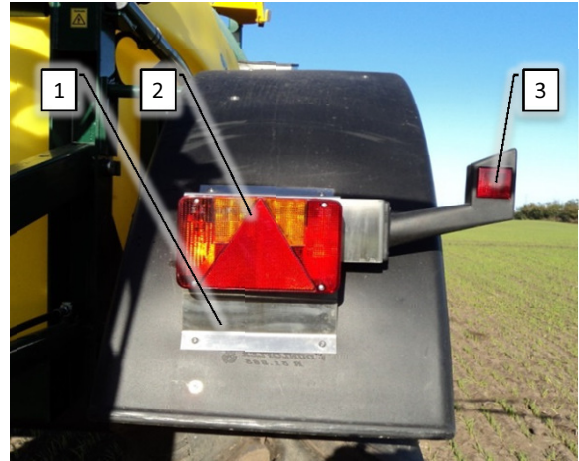
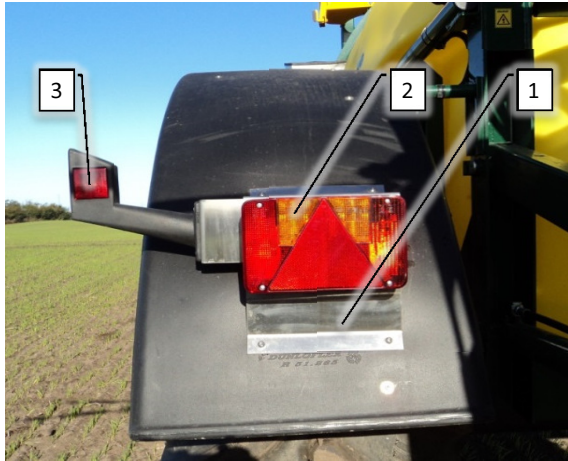

Pos	Psc	Number	Name	Price	Note
1	1	90330412	Lygteholder rustfri venstre CC		
2	1	90400130	Lygte m trekant CC venstre		
		1 90400084	Pære 21/5W, 12 V		
		2 90400150	Pærer 12V/21W til lygter CC		
3	1	90400141	Slingrelygte Hella CC		
		1 90400211	Pære 12V/5W		
4	1	90330409	Lygteholder rustfri højre CC		
5	1	90400131	Lygte med trekant CC højre		
		1 90400084	Pære 21/5W, 12 V		
		2 90400150	Pærer 12V/21W til lygter CC		
6	1	90400049	Anhængerstik 7 ledet han		
		15 90400109	Ledning 6x1 + 1x2,5 hvic		

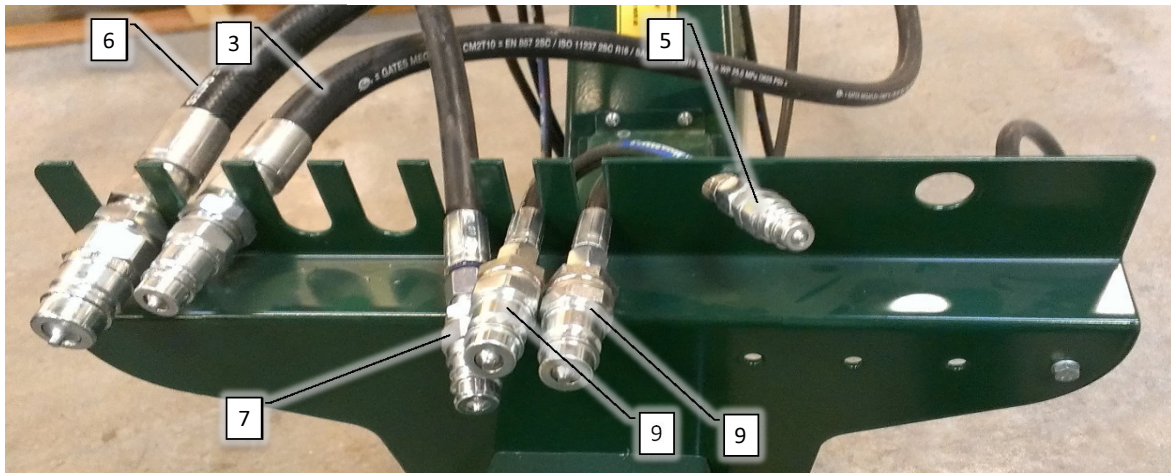
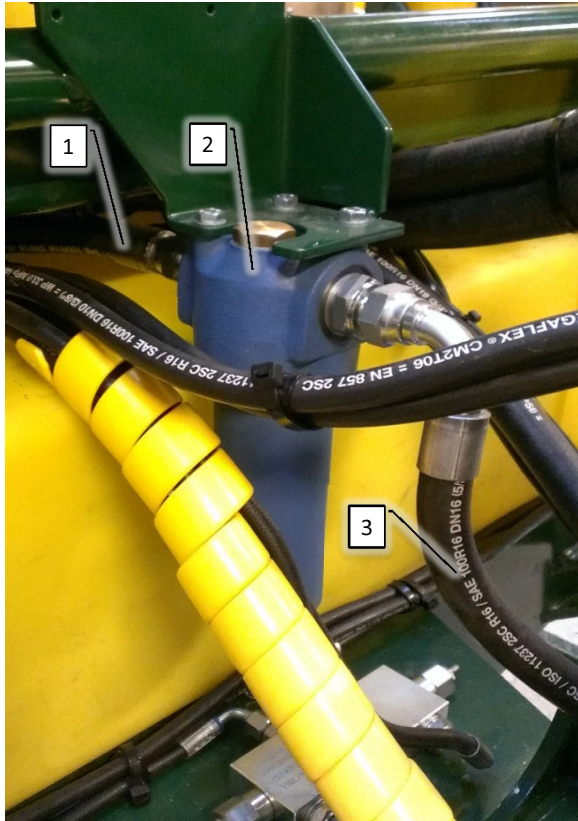

Pos	Psc	Number	Name	Price	Note
1	1	90515185	Hy slange CCII Trykslange 820mm		
2	1	90510051	Mahle filter PI3608+PI1108		
	2	90510045	Hy brystnippel 5/8' x 3/4'		
3	1	90515186	Hy slange CCII Trykslange traktor 4000mm		
	1	90510235	Hy nippel 1/2x5/8 BSP M/M		
	1	90510032	Lynkobling 1/2' har		
4	15	90510400	Olie Total Dynatrans MPV		
5	1	90515180	Hy slange CCII Ls 4900mm		
	2	90510040	Hy brystnippel 1/4' x 1/4' BSP Male		
	1	90510301	Hy lynkobling 1/4"		
6	1	90510177	Hy tee 3/8 BSP t-stk M/F/M		
	1	90510306	Hy lynkobling 3/4"		
	1	90515190	Hy slange CCII Retur PVG 500mm		
	1	90515188	Hy slange CCII Retur traktor 4100mm		
	2	90515204	Hy prop 1/2		
7	1	90510303	Hy lynkobling NV38GASM		
9	1	90510032	Lynkobling 1/2' har		
	1	90510043	Hy brystnippel 3/8'x1/2		
14	1	90515047	Hy slange CCII bremseslange 7000 mm		
	1	90510233	Hy nippel 1/4x1/2 BSP M/M		
	1	90320380	Lynkopling f. bremser		

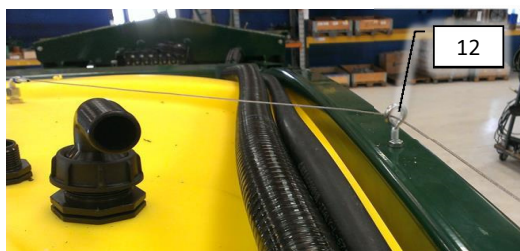
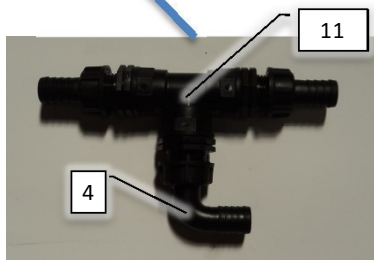
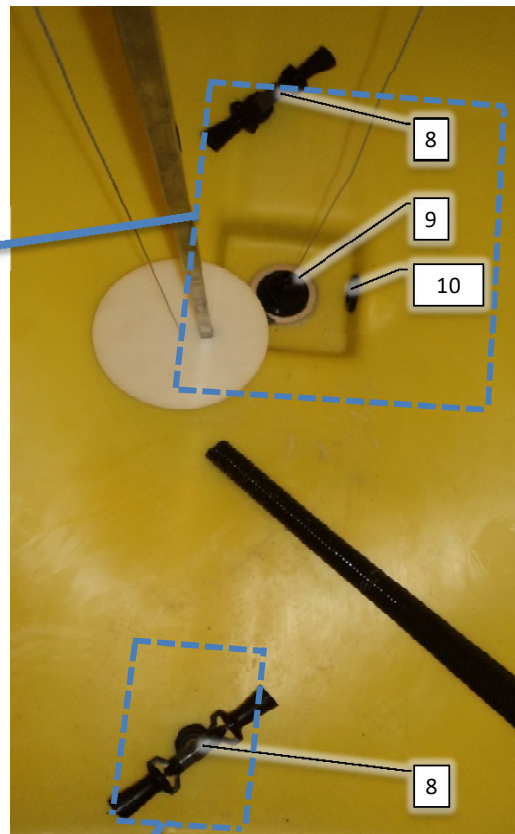
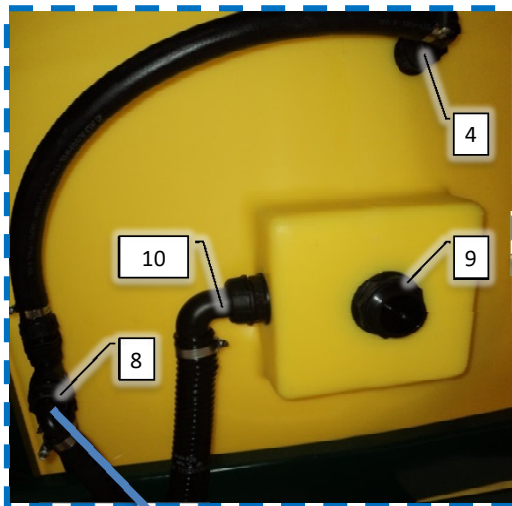
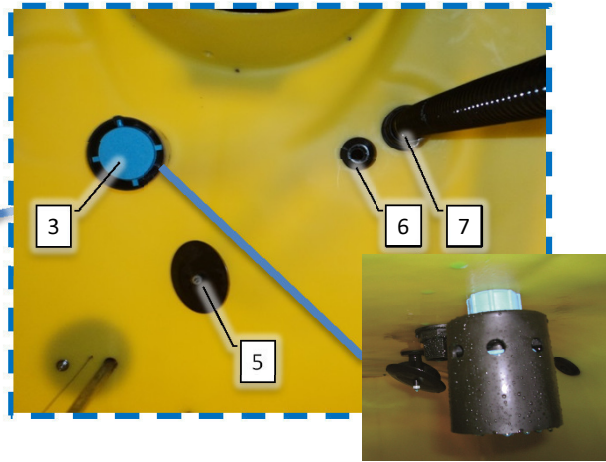
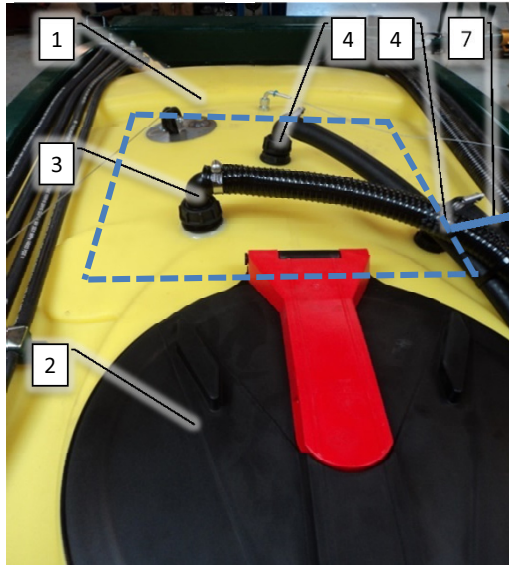

Pos	Psc	Number	Name	Price	Note
1	1	90320358	Væskebeholder 3000 l Concord		
2	1	90320359	Låg for væskebeh 1000L/ 3000L		
		1 90320360	Filterkurv f. væskeb. CC & AE		
3	1	90320531	UDG:Slangest. G1 1/4"x32mm 90G		
		1 90320513	Omløber G1 1/4' ARAG		
		2 90325026	O-ring G1 1/4' Arag		
		1 90210095	Spændebånd 30-45/12 C7 W3		
		1 90325100	Nippelreduktion G1 1/4"xG1' ARAC		
		1 90329066	Autotanker/svømmer 1"ind. gevinc		
		1 90320027	Pakning for G1' omløber, tankg. ARAC		
4	1	90320335	Slangest. G1'x25mm 90G ARAG		
		1 90320518	Omløber G1' ARAG		
		2 90325013	O-ring G1' Arag		
		1 90210186	Spændebånd 20-32/12- C7 W3		
5	1	90320093	Tankspuler (kunststof)		
		1 90320027	Pakning for G1' omløber, tankg. ARAC		
		1 90320026	Bægmøtrik G1' ARAG		
6	1	90320025	Brystnippel G1' lang ARAG		
		1 90320026	Bægmøtrik G1' ARAG		
		1 90320027	Pakning for G1' omløber, tankg. ARAC		
7	1	90325042	Slangest. G1 1/2"x35mm ARAG		
		1 90325064	Pakning G1 1/2' Arag		
		1 90320519	Bægmøtrik G1 1/2' ARAG		
		1 90320577	Slangestuds 1½"x36x90gr. O-ring projekt		
		1 90320491	UDG:Slangest. G1 1/2'x35mm		
		2 90325063	Omløber G1 1/2' ARAG		
		2 90325016	O-ring G1 1/2' Arag		
8	2	20200090	Omrøring AB CC		
9	1	90320272	Bundventil 2' m/snor ECC		
		3 90211105	Wire rustfri 1,5mm AISI 316 syrefast		
		1 90510150	Hy Skotgennemføring 1/4		
		1 90510196	Hy slangekob 1/4 BSP F 90 1/4		
10	1	90320137	Tankgennemføring G1 1/2' ARAC		
		1 90325064	Pakning G1 1/2' Arag		
		1 90320519	Bægmøtrik G1 1/2' ARAG		
		1 90320532	Slangest. G1 1/2'x40mm 90G ARAG		
		1 90325063	Omløber G1 1/2' ARAG		
11	1	90320255	T-stykke G1' F-F-F ARAG		
		3 90325061	Brystnippel G1' ARAG		
		2 90325012	Slangest. G1'x25mm ARAG		
		2 90320518	Omløber G1' ARAG		
12	1	90210276	Øjebolt fz M6		

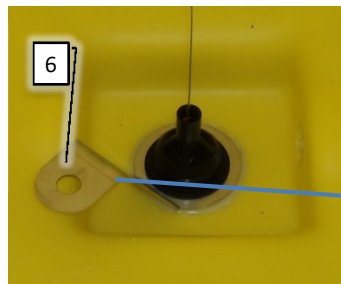
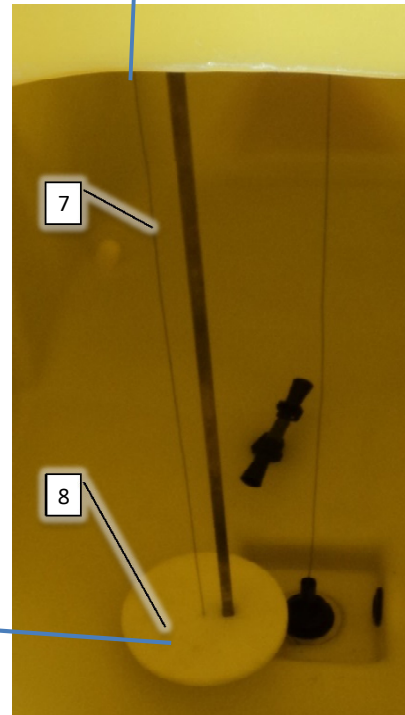
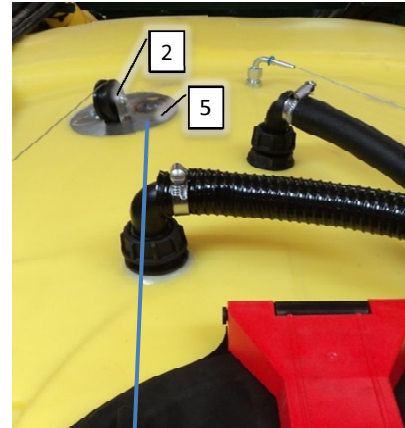
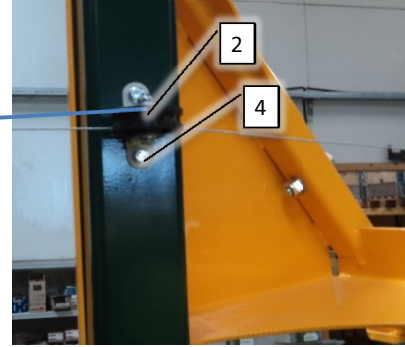
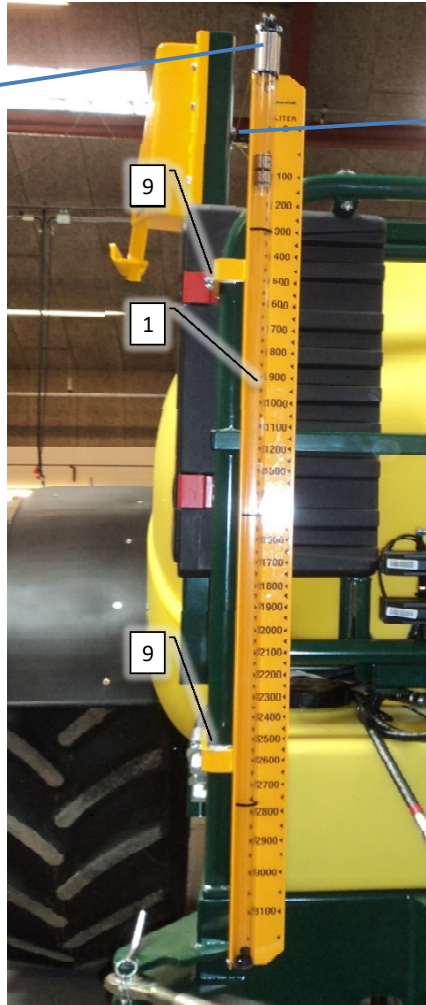
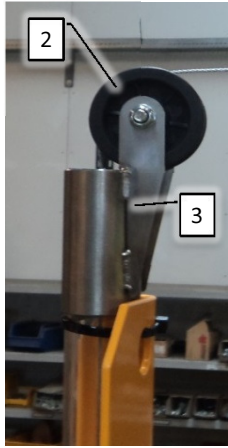

Pos	Psc	Number	Name	Price	Note
1	1	90330386	Tankmålerkonsol CC		
	1	90900056	Mærkat- tankskala CC		
	1	90336947	Målerør (1850mm) f. tankmåler		
	1	90336945	Lod f. tankmåler		
	2	90320809	Prop ø32x26 t, tankmåler CC		
2	1	90320850	Hjul f. wire t. tankmåler		
	1	90330212	Bøsning f. hjul t. tankmåler		
3	1	90336943	Trisseholder f. skalarør f. tankmåler		
4	1	90336942	Holder f. rulle f. tankmåler		
5	1	90336941	Tank sonde f. tankmåler		
6	1	90336946	Tankbund holder f. tankmåler		
7	3,75	90211105	Wire rustfri 1,5mm AISI 316 syrefast		
	2	90211106	Taluritlås kobber 1,5mm wire EN13411-3		
8	1	90336944	Flydeplade f. tankmåler		
9	1	90215007	Udstødningsclamps 48mm		

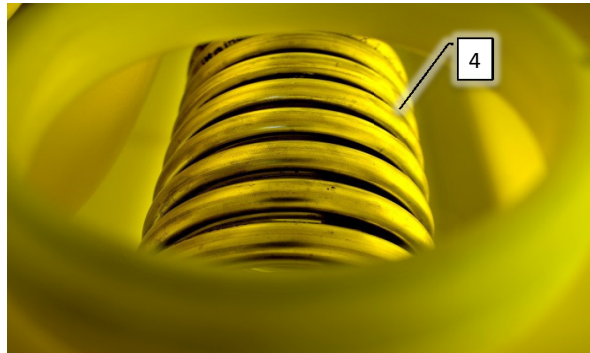
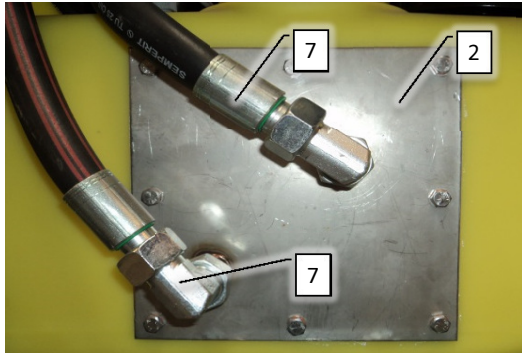
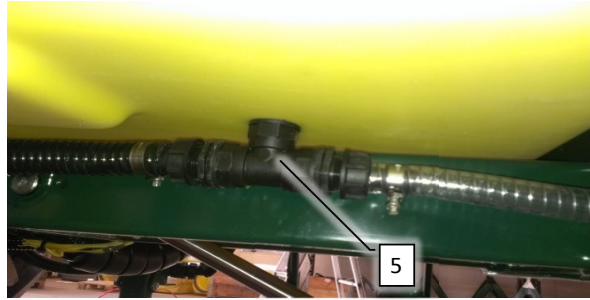
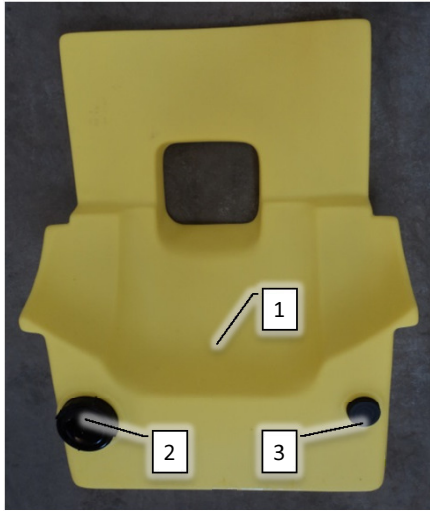

Pos	Psc	Number	Name	Price	Note
1	1	90320363	Rentvandstank CC 260 liter		
		90320361	Låg lille for rentvandtank CC&AB		
		90320362	Låg stor for rentvandtank CC&AB		
2	1	90330096	Oliekølerspiral f vandtank CC		
	16	90214414	Skive M8 8,4x24x2 A2 Skærm		
	16	90510516	Kobberring Ø8x14x1		
	8	90214420	Bolt M8x25 A2		
	8	90210353	Møtrik M8 A2		
5	1	90320088	Tankgennemføring G1' ARAG		
	1	90320027	Pakning for G1' omløber, tankg. ARAG		
	1	90320255	T-stykke G1' F-F-F ARAG		
	1	90320432	Slangest. G1'x20mm ARAG		
	2	90320518	Omløber G1' ARAG		
	2	90325061	Brystnippel G1' ARAG		
	1	90325012	Slangest. G1'x25mm ARAG		
	4	90325013	O-ring G1' Arag		
	2	90210088	Spændebånd 12-22/9 C7 W3		
7	1	90515191	Hy slange CCII Kølespiral 600mm		
	1	90510259	Hy vinkel 22mm		
	1	90517603	Dobbelt skærring ø22		
	1	90517604	Hy Omløber ø22 M30x2		

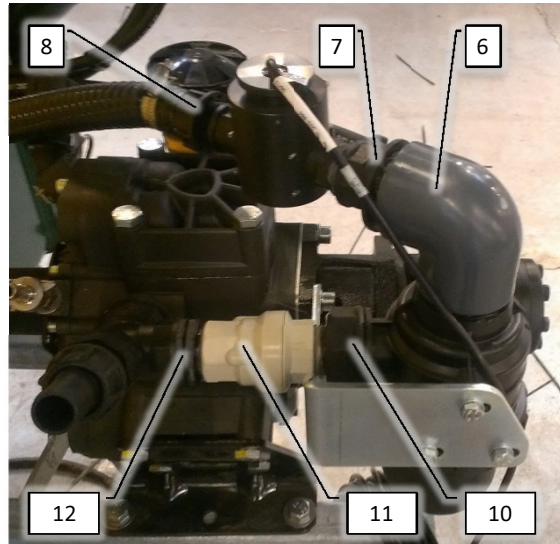
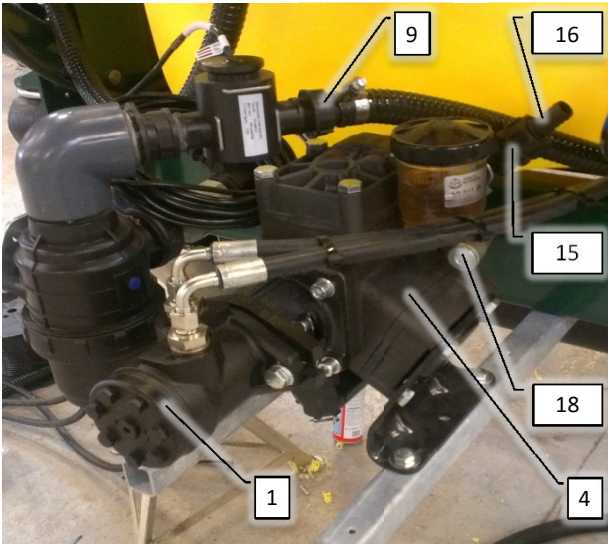
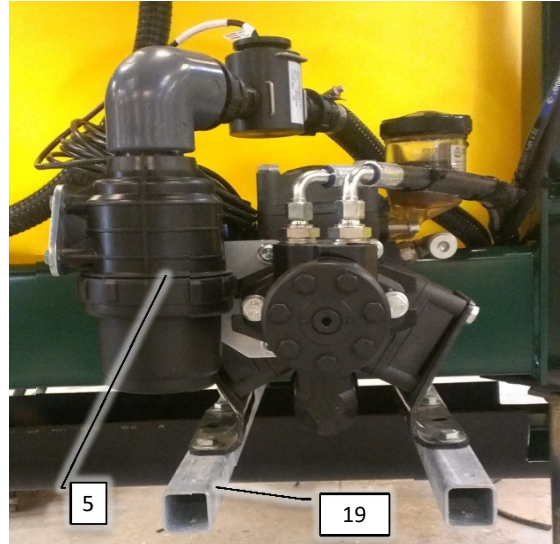
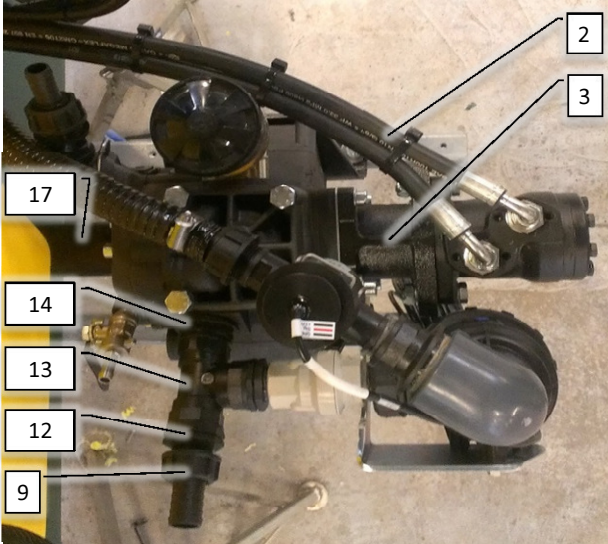

Pos	Psc	Number	Name	Price	Note
1	1	90510047	Oliemotor OMP 25 AB		
2	1	90515192	Hy slange CCII Væskepumpe Inj. 3800mm		
		1 90510043	Hy brystnippel 3/8'x1/2'		
		1 90510057	Bonded seal hydr.1/2'		
3	1	90510421	Flange f/SAE-A m/ø25 f/AR813		
		2 90210017	Bolt M12x30 FZB 8.8 ubryst		
		2 90210056	Møtrik M12 FZB låse		
		4 90214408	Skive M12 FZB Facet		
4	1	90320357	Væskepumpe 3 cyl AR 813		
		4 90210031	Bolt M10x50 FZB 8.8 ubryst		
		4 90210055	Møtrik M10 FZB låse		
		8 90214407	Skive M10 FZB Facet		
5	1	90320045A	Sugefilter kpl.1 1/2'/blå!50m		
		1 90330272	Filterkonsol pumpe injek. CC I		
		3 90210010	Bolt M8x16 FZB 8.8 ubryst		
		3 90214406	Skive M8 FZB Facet		
6	1	90320231	Vinkel 1 1/2' grå		
7	1	90320237	Spidsmuffe 1 1/2' x 1'		
8	2	90400196	1" gevindstuds f. flowmåler		
		1 90400018	Flowmåler Ø16mm x 10m ledning		
		2 90327400	O-ring f. flowmåler (side)		
9	1	90325012	Slangest. G1'x25mm ARAG		
		1 90320518	Omløber G1' ARAG		
		2 90325013	O-ring G1' Arag		
		1 90210186	Spændebånd 20-32/12- C7 W3		
10	1	90320341	Nippelmuffe G1 1/2'xG1' ARAG		
11	1	90320400	Kontraventil rent vand 1'		
12	1	90325061	Brystnippel G1' ARAG		
13	1	90320255	T-stykke G1' F-F-F ARAC		
14	1	90325100	Nippelreduktion G1 1/4'xG1' ARAC		
15	1	90325102	UDG: Nippelmuffe G1'xG3/4'		
16	1	90320432	Slangest. G1'x20mm ARAG		
		1 90320518	Omløber G1' ARAG		
		2 90325013	O-ring G1' Arag		
		1 90210186	Spændebånd 20-32/12- C7 W3		
17	1	90310067	Afdækning f. spline aksel AF		
18	1	90515204	Hy prop 1/2'		
		1 90510057	Bonded seal hydr.1/2'		
19	2	90336949	Holder f. højtryksrenserulle		

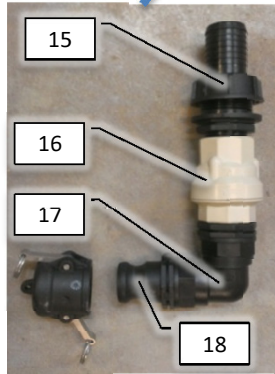
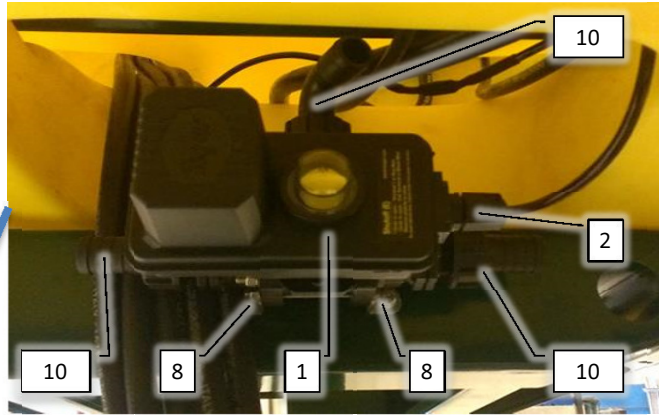
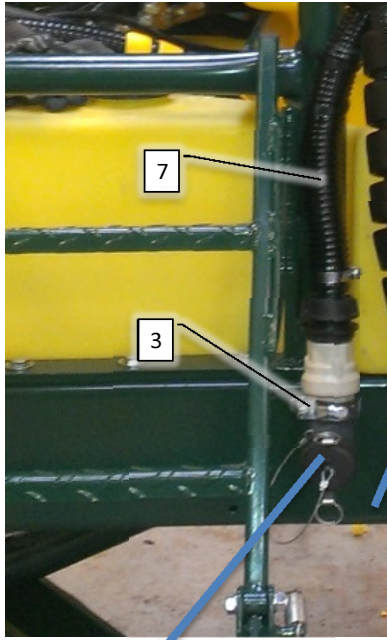

Pos	Psc	Number	Name	Price	Note
1	1	90400012	Motorventil 1' 3-vej gødn/inj.		
2	1	90400161	Kabel f motorventil 6m		
3	1	90215021	Rørophæng M8 Ø32-35mm		
4	2,8	90340044	Slange 25 mm sug		
5	3	90340044	Slange 25 mm sug		
6	4,5	90340044	Slange 25 mm sug		
7	2,5	90340006	Slange 32 mm sug		
8	1	90320411	Beslag for motorventil		
	2	90210330	Bolt M6x12 FZB 8.8 ubrust		
	2	90214406	Skive M8 FZB Facet		
10	1	90320504	Slangest. G1 1/4'x25mm 90G ARAG		
	1	90320513	Omløber G1 1/4' ARAG		
	2	90325026	O-ring G1 1/4' Arag		
	1	90210098	Spændebånd 16-27/12 C7 W		
15	1	90320503	Slangest. G1 1/4'x32mm ARAG		
	1	90320513	Omløber G1 1/4' ARAG		
16	1	90325100	Nippelreduktion G1 1/4'xG1' ARAC		
	1	90320400	Kontraventil rent vand 1'		
	1	90325061	Brystnippel G1' ARAG		
17	1	90320454	Vinkel G1 90G F-F ARAG		
18	1	90320036	Lynkobling TypeF M1'xMG1		
	1	90320047	Lynkobling TypeH Prop 1		
	0,5	90211105	Wire rustfri 1,5mm AISI 316 syrefast		

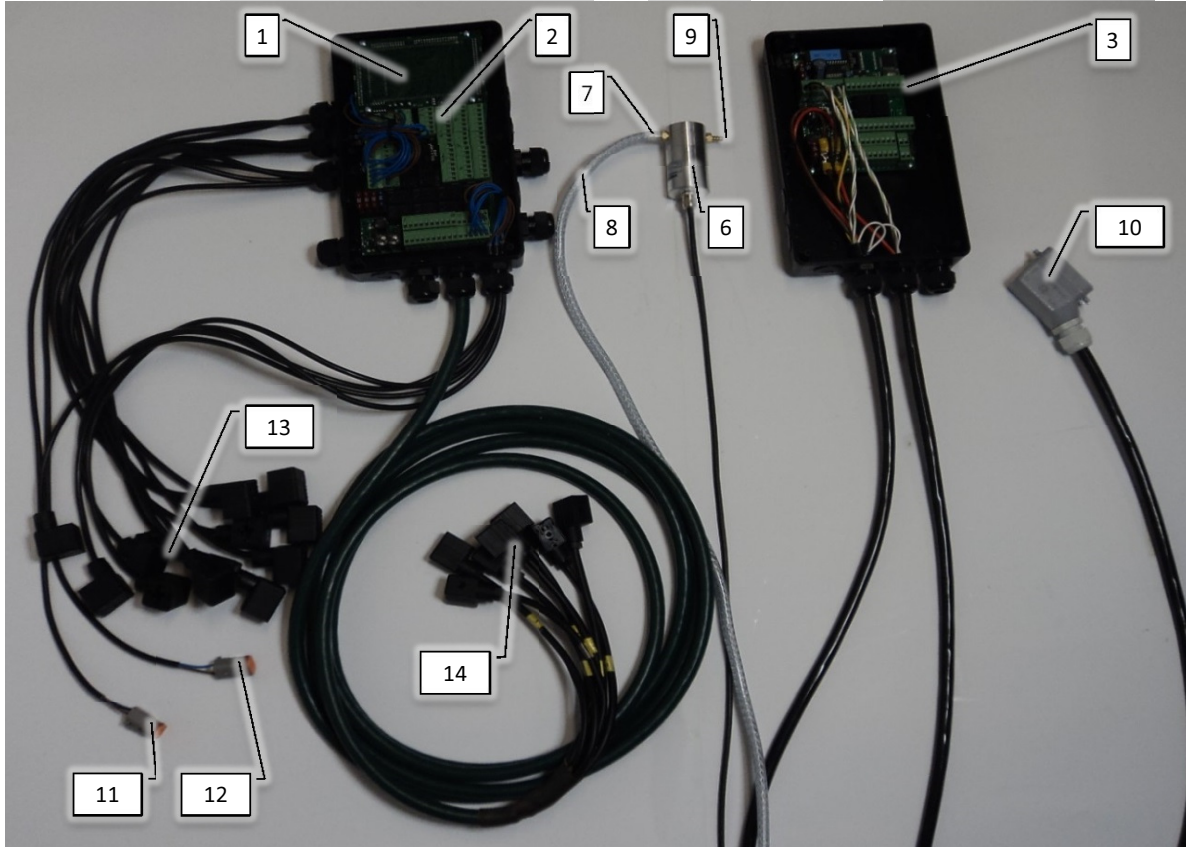

Pos	Psc	Number	Name	Price	Note
1	1	90404601	Jobcomputer f/Spray Controller V1		
2	1	90404640	Print t/jobcomputer (løs) Lykketronic		
3	1	90404602	Mini jobcomputer f/Spray Controller V1		
4	1	90404609	Joystick f/Spray Contr. CCII		
5	1	90404650	Montageskinne Lykketronic enhec		
6	1	90404605	Tryktransmitter t/luftstyring		
7	3	90807360	Slangenippel t/tryktransducer 1/8" x 5		
8	3	90340010	Klar slange luft 5 mm		
9	0,5	90340010	Klar slange luft 5 mm		
10	1	90400214	Injektionskabel CC II		
11	1	90407518	for 4-pole female holder		
	1	90407517	4-pole connector female		
	2	90407524	female type		
	7,5	90400037	Kabel 2x0.75 sort kappe		
12	1	90407518	for 4-pole female holder		
	1	90407517	4-pole connector female		
	3	90407524	female type		
	7,5	90400036	Kabel - 3 x 0,75 mm ² sort kappe		
13	1	90400170	Stik f. hyd. ventil incl. ledning 2000mm		
14	1	90400163	Stik f. væskeventil incl. 1,3m ledning		
A	1	20200052	Dele f. montering på traktor inj. AB-CC		

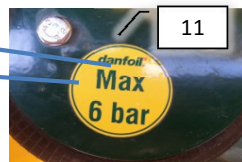
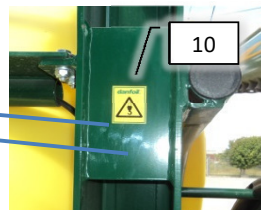
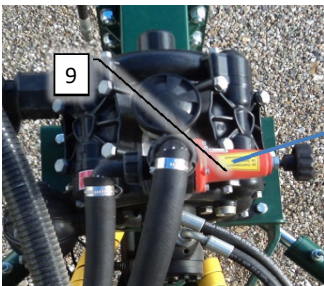
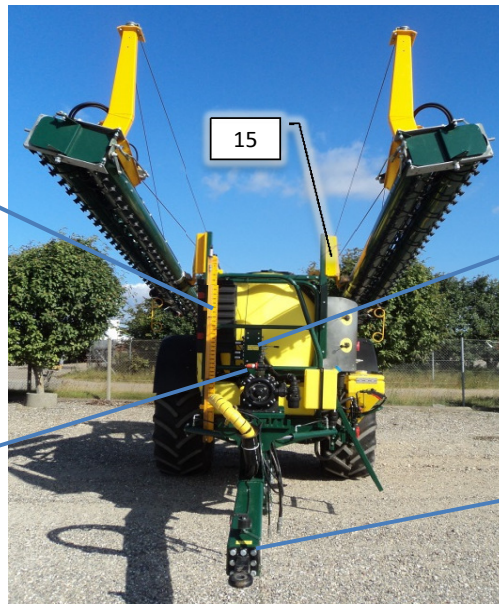
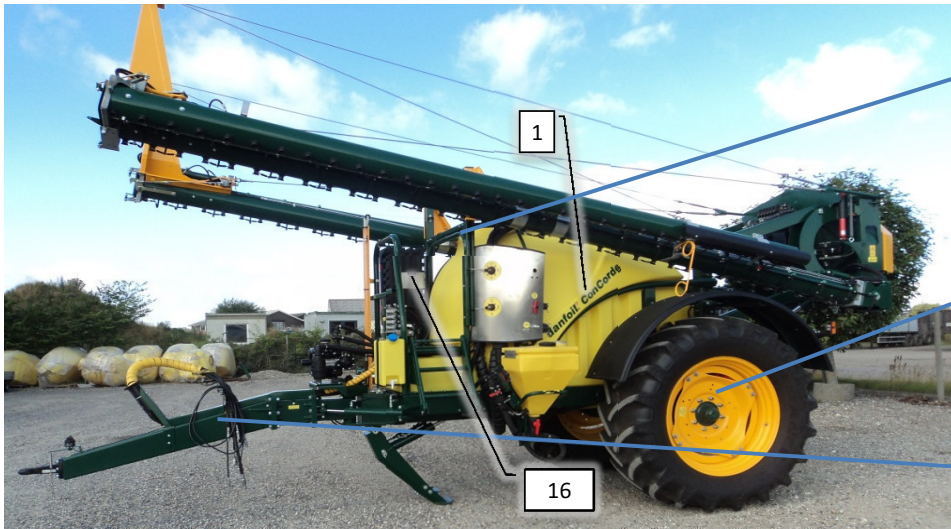

Pos	Psc	Number	Name	Price	Note
1	2	90900052	Mærkat - tank CC		
2	1	90900079	Mærkat-advarel-farlig kemi i tank		
3	1	90900083	Mærkat-advarel-læs instruktionsbog		
4	2	90900064	Mærkat- HUSK efterspænd hjulbolt		
5	1	90900162	Mærkat "frakobling af hydraulikslanger"		
6	1	90900171	Mærkat "RPM high-low"		
7	2	90900170	Mærkat "efterspænding af bolte"		
8	1	90900174	Mærkat - værnemidler f. værktøjsskab		
9	1	90900172	Mærkat "Overtryksventil"		
10	2	90900167	Mærkat "max. 6 bar"		
11	4	90900168	Mærkat "anhugningspunkt"		
12	1	90900169	Mærkat " danfoil PC-Spray Controller"		
13	1	90900164	Mærkat "DK- frakobling af akkumulator"		
14	1	90900173	Mærkat "strømforsyning/sikringsbox"		
15	2	90900063	Mærkat - Danfoil bomkonsol CC		
16	1	90900180	Mærkat "KEMI" til plade		

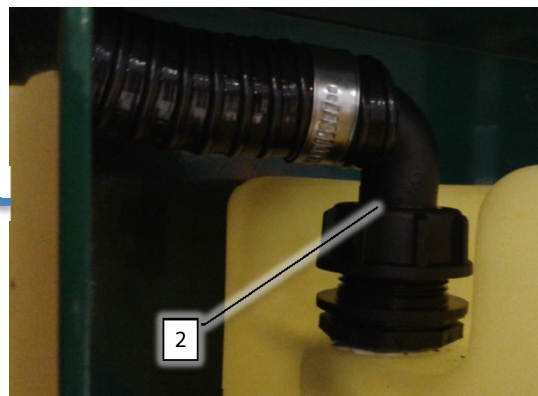
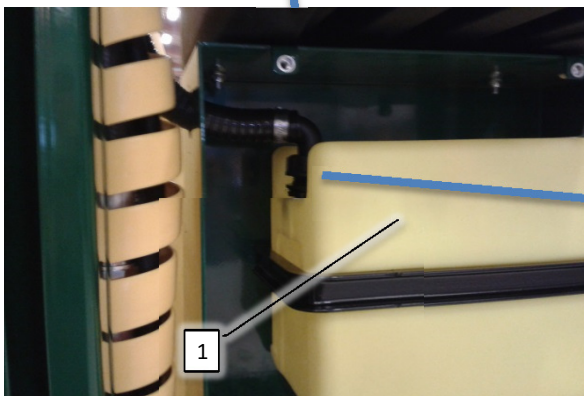
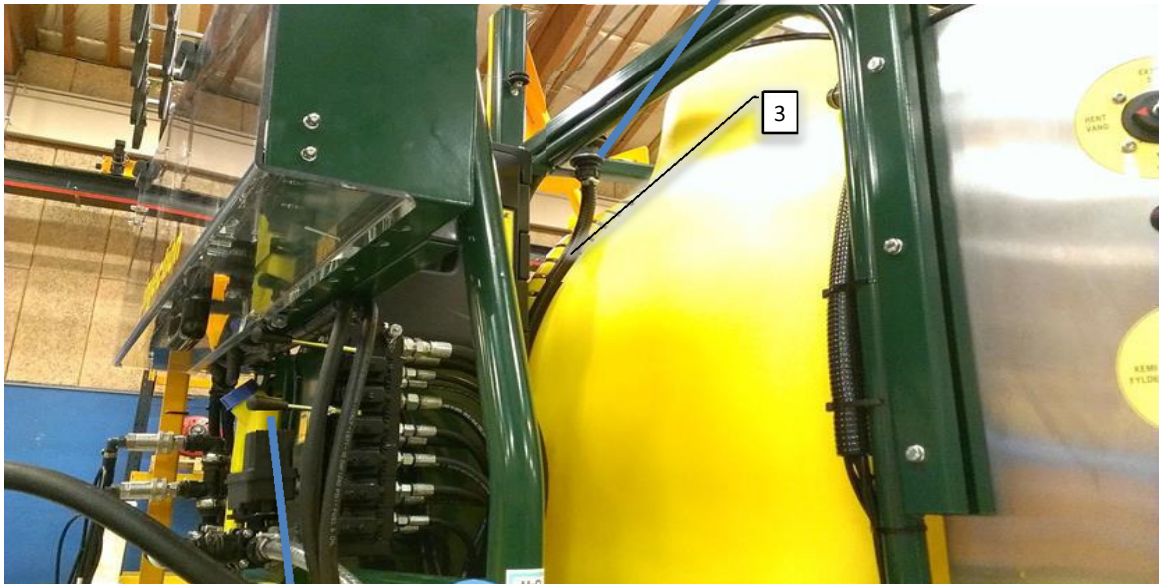
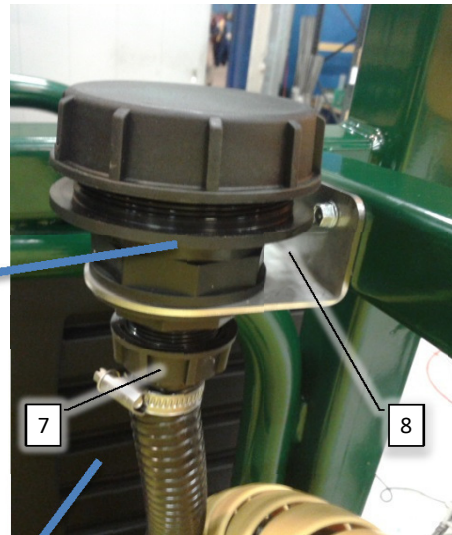
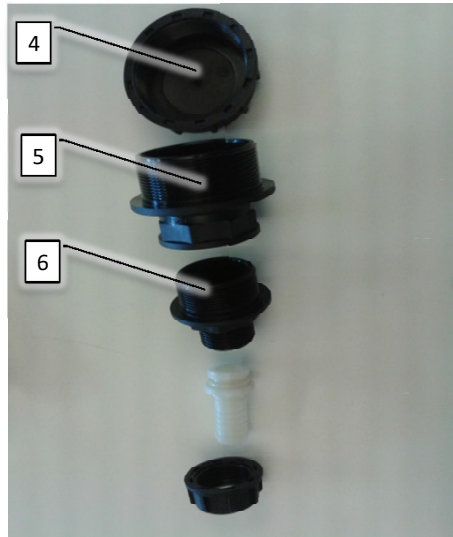

Pos	Psc	Number	Name	Price	Note
1	1	90320368	Vandtank 15 l komplet Gul		
2	1	90320458	Nippelreduktion G1'xG3/4' ARAG		
	1	90320335	Slangest. G1'x25mm 90G ARAG		
	1	90320518	Omløber G1' ARAG		
	2	90325013	O-ring G1' Arag		
	1	90210089	Spændebånd 25-40/12 C7 W3		
3	1,2	90340044	Slange 25 mm sug		
4	1	90321300	Låg G3'		
5	1	90321301	Nippelmuffe G3'xG2' ARAG		
6	1	90321302	Nippelreduktion G2'xG1 1/4' ARAG		
7	1	90320501	Slangest. G1 1/4'x25mm ARAG		
	1	90320513	Omløber G1 1/4' ARAG		
	2	90325026	O-ring G1 1/4' Arag		
	1	90210089	Spændebånd 25-40/12 C7 W3		
8	1	90330298	Holder for påfyldningstragt		
	2	90210061	Selvsikærende skrue 6,3x 22mm		



Pos	Psc	Number	Name	Price	Note
1	1	90330380	Stige topdel CC		
	1	90310052	Fjeder til trinbræt CC II		
	2	90320800	Prop stige 40x20x3-1 CC		
2	1	90330342	Stige bunddel 3-trin CC		
	2	90320800	Prop stige 40x20x3-1 CC		

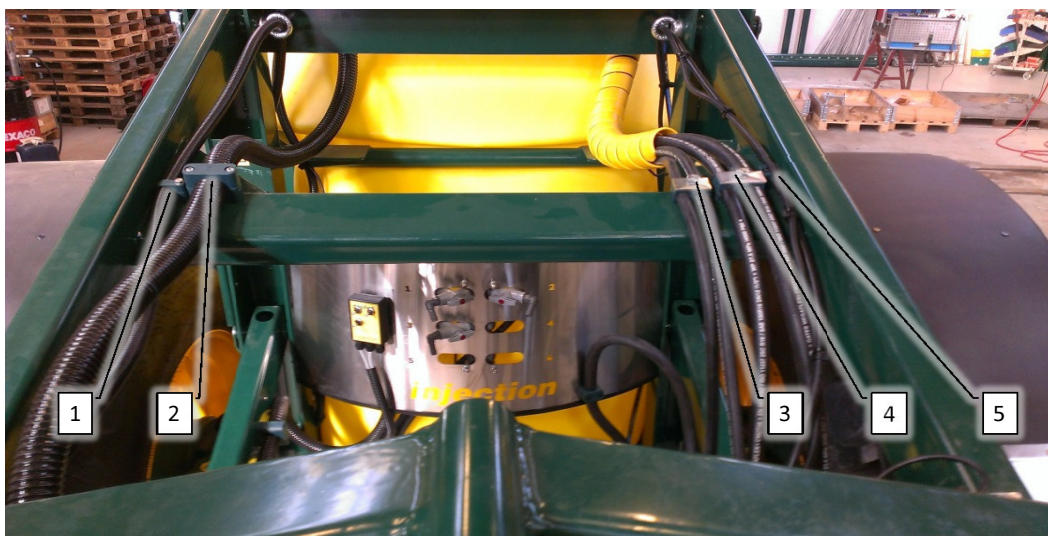

Pos	Psc	Number	Name	Price	Note
1	1	90320750	Rørholder 25 mm enkelt		x
2	1	90320707	Rørholder 40mm enkelt		
		1 90210321	Bolt M10x60 FZB 4.6 Bræddebolt		
3	1	90320709	Rørholder 3/8" x 3/8" db. inkl. topplade		
		1 90210321	Bolt M10x60 FZB 4.6 Bræddebolt		
4	1	90320703	Rørholder 22x22 m/top kpl.		
5	1	90320702	Rørholder 12mm enkelt		
		1 90320755	Rørholder 35mm enkelt		

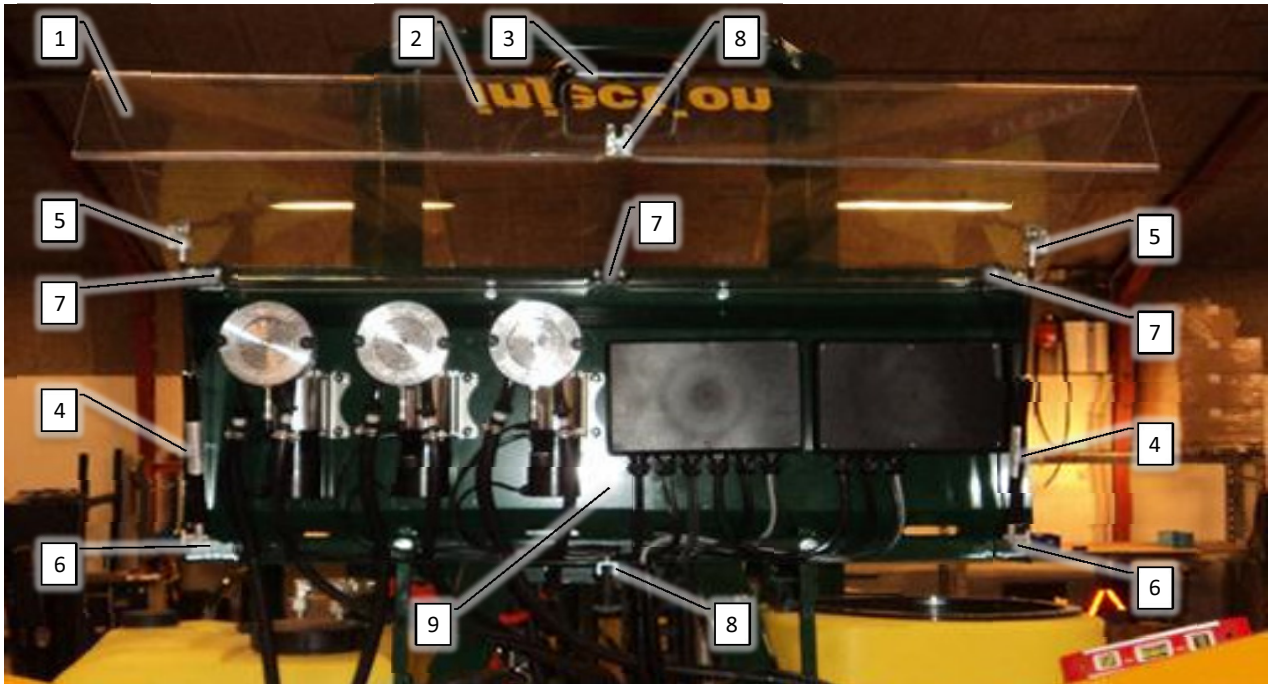

Pos	Psc	Number	Name	Price	Note
1	1	90403420	Frontdæksel t/injektionsskab		
2	1	90900042	Mærkat - injection		
3	1	90320074	Håndgreb M 243/140		
	2	90210011	Bolt M8x20 FZB 8.8 ubrust		
	2	90210084	Skive M8 8,4x25x2 Plan		
4	1	90403423	Gasfjeder f/injektionsskab		
	2	90403426	Endestykke f/gasfjeder		
5	1	90403425	Beslag f/gasfjeder - vinkel		
	2	90210219	Bolt M6x16 FZB buttonhead		
	2	90210083	Skive M6,4x18x1,6 Plan		
	1	90403429	Låsering Ø8 udv.		
	2	90210260	Møtrik M6 A2 Top		
6	1	90403424	Beslag f/gasfjeder - lige		
	2	90210219	Bolt M6x16 FZB buttonhead		
	1	90403429	Låsering Ø8 udv.		
	2	90210053	Møtrik M6 FZB låse		
7	1	90403422	Hængsel f/injektionsskab		
	4	90210219	Bolt M6x16 FZB buttonhead		
	2	90214405	Skive M6 FZB Facet		
	2	90210083	Skive M6,4x18x1,6 Plan		
8	2	90214418	Bolt M5x30 FZB 8.8 unsæ. umbr.		
	2	90210075	Skive M5 FZB Facet		
		2 Mangler			
	1	90210123	Gummihjelmsholder		
	1	90214418	Bolt M5x30 FZB 8.8 unsæ. umbr.		
	1	90210075	Skive M5 FZB Facet		
		1 Mangler			
9	1	90403421	Skab f.injektionsskab		

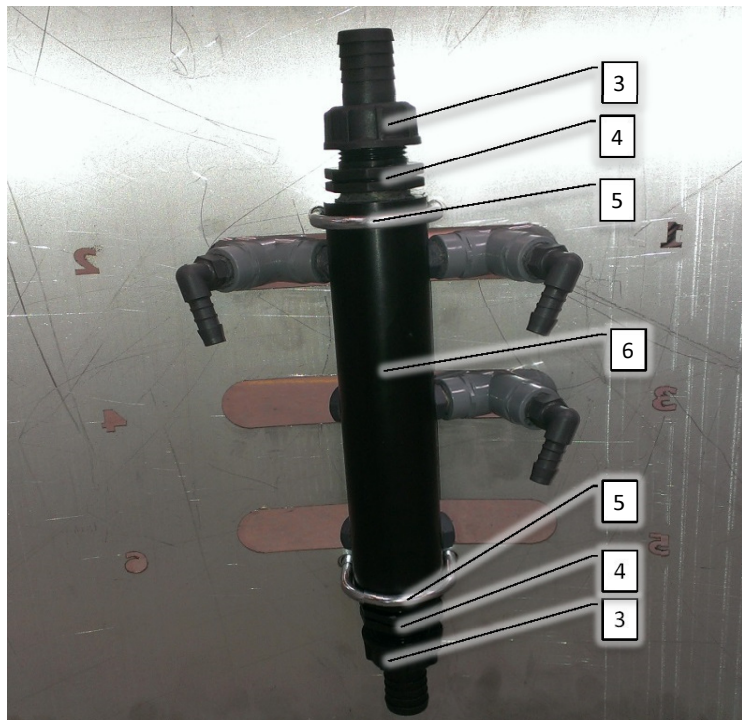
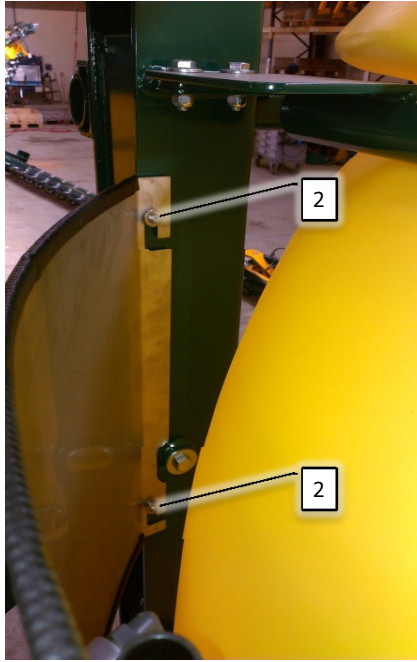

Pos	Psc	Number	Name	Price	Note
1	1	90330520	Bagpanel CCII		
	2	90330067	Kantliste til luftkasse CC & AB		
	1	90900042	Mærkat - injection		
2	1	90210240	Bolt M8x30 FZB 8.8		
	1	90330612	Bøsning Ø12x1,5x10 AISI 304 hy. rør		
	1	90214419	Skive M8 A2 Ø8,4mm		
3	1	90325012	Slangest. G1'x25mm ARAG		
	1	90320518	Omløber G1' ARAG		
	2	90325013	O-ring G1' Arag		
	1	90210186	Spændebånd 20-32/12- C7 W3		
4	1	90325061	Brystnippel G1' ARAG		
5	1	90215030	Udstødningsclamps 52mm		
	2	90210261	Møtrik M8 A2 Top		
6	1	90320710	Rørstuds f. kalibr.manifold		
	5	90320582	Prop G3/8' udv. gevind		
7	2	90320750	Rørholder 25 mm enkelt		
	3,05	90340044	Slange 25 mm sug		

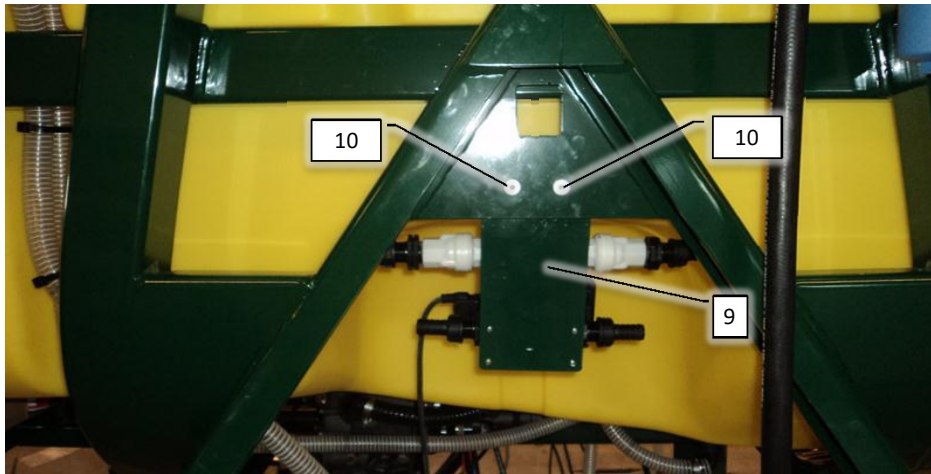
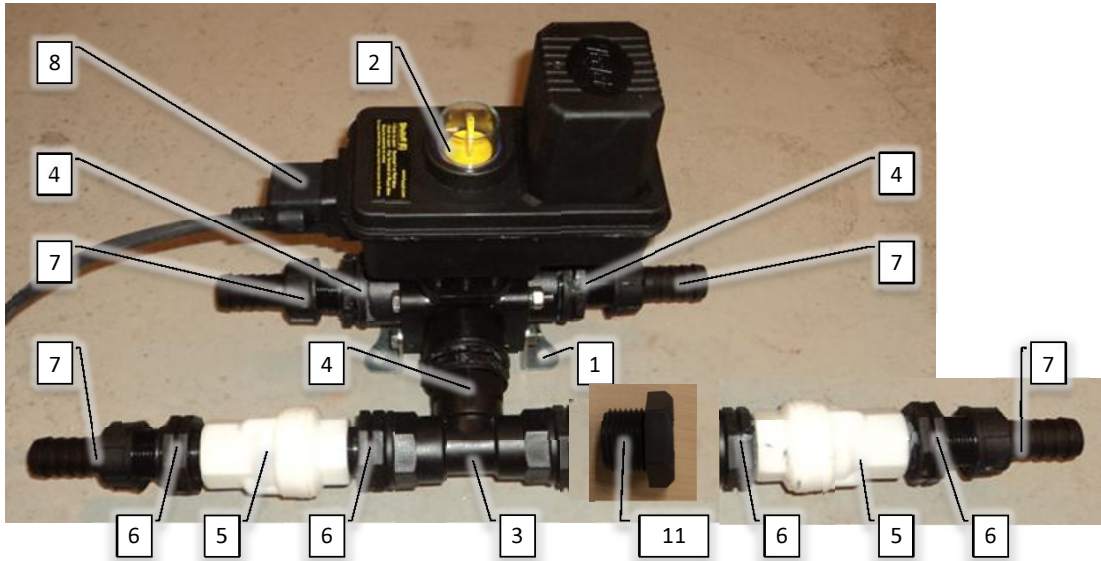

Pos	Psc	Number	Name	Price	Note
1	1	90320411	Beslag for motorventil		
	2	90210002	Bolt M6x20 FZB 8.8 ubryst		
	2	90214405	Skive M6 FZB Facet		
2	1	90400012	Motorventil 1' 3-vej gødn/inj.		
3	1	90320409	T-stykke G3/4' F-F-F ARAG		
	3	90320651	O-ring 25,00x3,0		
4	1	90320458	Nippelreduktion G1'xG3/4' ARAG		
5	1	90320034	Kontraventil rent vand 3/4'		
6	1	90320322	Brystnippel G3/4' ARAG		
7	1	90320431	Slangest. G3/4'x20mm ARAG		
	1	90320429	Omløber G3/4' ARAG		
	2	90325024	O-ring G3/4' Arag NBR		
	1	90210088	Spændebånd 12-22/9 C7 W3		
8	1	90400161	Kabel f motorventil 6m		
9	1	90330610	Mont.beslag f. motorvent. rensesys. AB		
10	1	90214421	Bolt M8x20 FZB 8.8 unders.		
11	1	90320030	Prop 3/4 '		

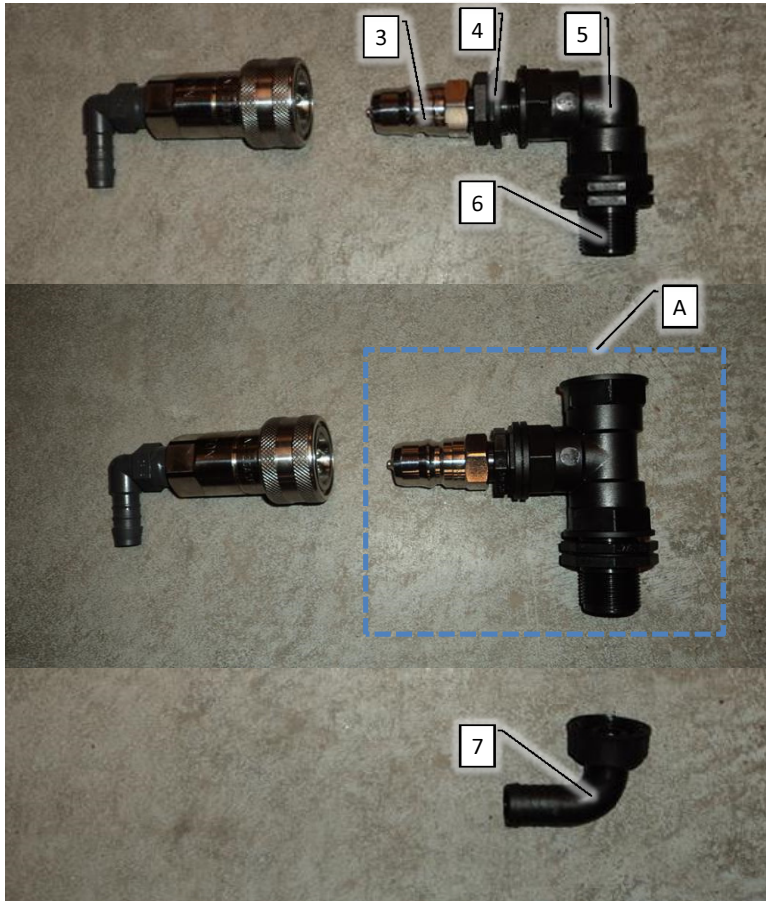

Pos	Psc	Number	Name	Price	Note
3	1	90320388	Lynkobling han 1/2' t/injekt		
4	1	90320483	Nippelreduktion G3/4'xG1/2' ARAG		
5	1	90320449	Vinkel G3/4' 90G F-F ARAG		
6	1	90320322	Brystnippel G3/4' ARAG		
7	1	90320433	Slangest. G3/4'x20mm 90G ARAG		
	1	90320429	Omløber G3/4' ARAG		
	2	90325024	O-ring G3/4' Arag NBR		
	1	90210088	Spændebånd 12-22/9 C7 W3		
8	1	90215021	Rørophæng M8 Ø32-35mm		
9	1	90330317	Gevindstykke M8x60 FZE		
A	0	60604115	Tilkoblingsstuds expander til rensesyste		

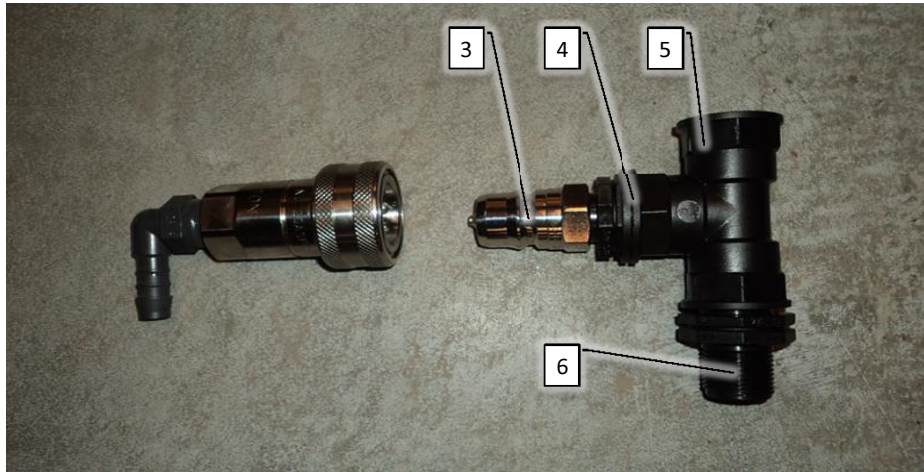

Pos	Psc	Number	Name	Price	Note
3	1	90320388	Lynkobling han 1/2' t/injekt		
4	1	90320483	Nippelreduktion G3/4'xG1/2' ARAG		
5	1	90320409	T-stykke G3/4' F-F-F ARAG		
6	1	90320322	Brystnippel G3/4' ARAG		
7	1	90215021	Rørophæng M8 Ø32-35mm		
8	1	90330317	Gevindstykke M8x60 FZE		

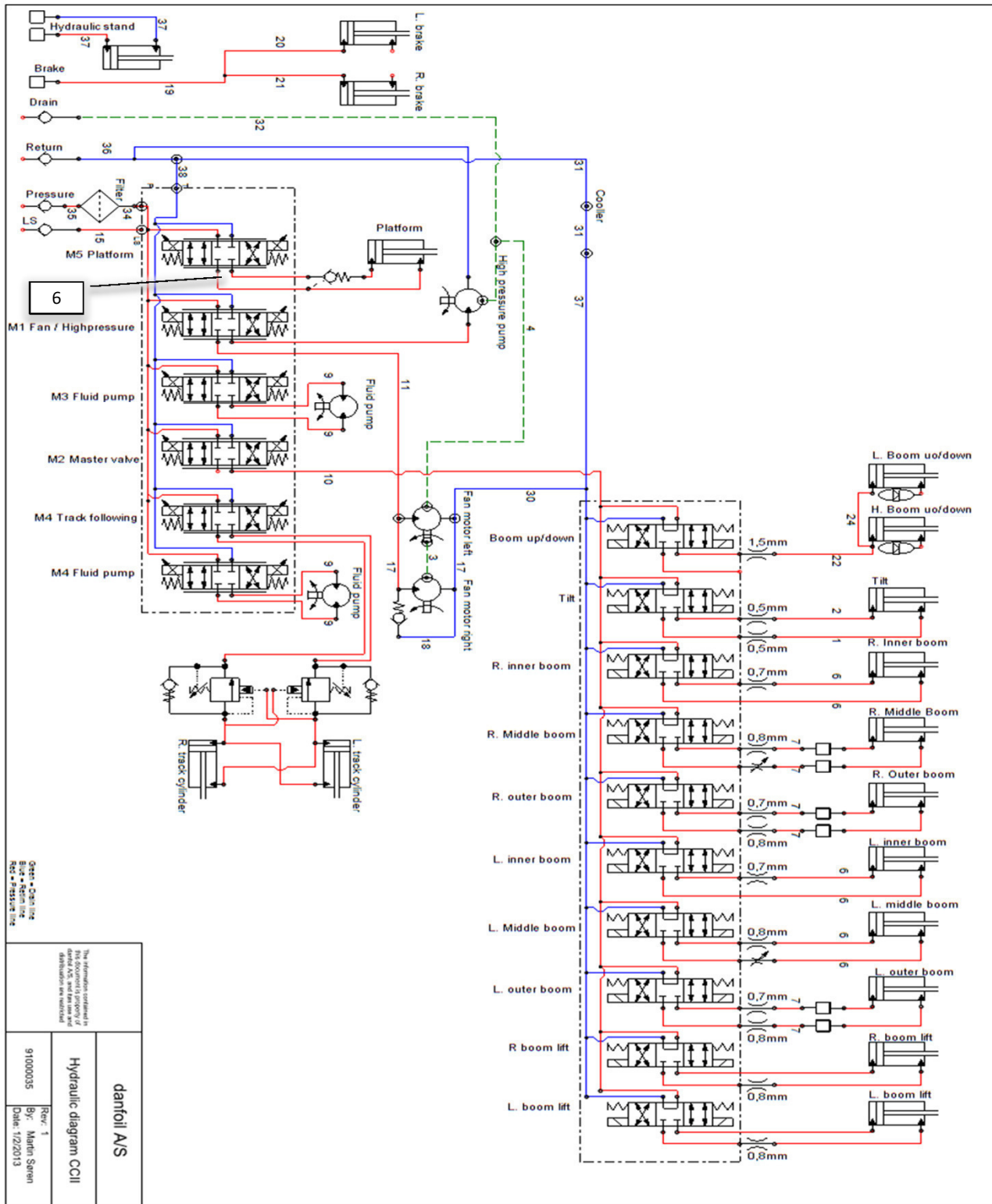

Genet. = Danfoils
 Bred = 40mm line
 Rød = 25mm line

danfoil AIS	
Hydraulic diagram CCII	
91000035	Rev. 1
By: Martin Søren	Dato: 11/2013

Pos	Psc	Number	Name	Price	Note
1	1	90515098	Hy slange CCII Tiltslange 750mm		
2	1	90515179	Hy slange CCII Tiltslange 600mm		
3	1	90515073	Hy slange AB CCII 1/4'dræn 620mm		
4	1	90515181	Hy slange CCII Dræn 6000mm		
6	6	90515077	Hy slange AB CCII 1/4' LS 1600mm		
7	8	90515178	Hy slange CCII Ydrebom 2300mm		
9	2	90515120	Hy slange CCII 3/8" væskepumpe 1200mm		
		2 90515192	Hy slange CCII Væskepumpe Inj. 3800mm		
10	1	90515183	Hy slange CCII Tryk PVG/LC 5650mm		
11	1	90515184	Hy slange CCII Motor slange 5900mm		
15	1	90515180	Hy slange CCII Ls 4900mm		
17	1	90515086	Hy slange AB CCII 1/2'motor 650mm		
18	1	90515087	Hy slange AB CCII 1/2' motor 550mm		
19	1	90515047	Hy slange CCII bremseslange 7000 mm		
20	1	90515177	Hy slange CCII Bremseslange 1700mm		
21	1	90515176	Hy slange CCII Bremseslange 900mm		
22	1	90515122	Hy slange CCII Lift 3500mm		
24	1	90515174	Hy slange CCII Lift 2000mm		
30	1	90515187	Hy slange CCII Retur blæser 950mm		
31	2	90515191	Hy slange CCII Kølespiral 600mm		
32	1	90515182	Hy slange CCII Dræn 3500mm		
34	1	90515185	Hy slange CCII Trykslange 820mm		
35	1	90515186	Hy slange CCII Trykslange traktor 4000mm		
36	1	90515188	Hy slange CCII Retur traktor 4100mm		
37	2	90515076	Hy slange AB CCII 1/4'bom 4700mm		
38	1	90515190	Hy slange CCII Retur PVG 500mm		
39	1	90515189	Hy slange CCII Retur LC 4500mm		
40	2	90515171	Hy slange track-control 570mm		
41	2	90515172	Hy slange track-control 1030mm		
42	2	90515173	Hy slange track-control 1600mm		

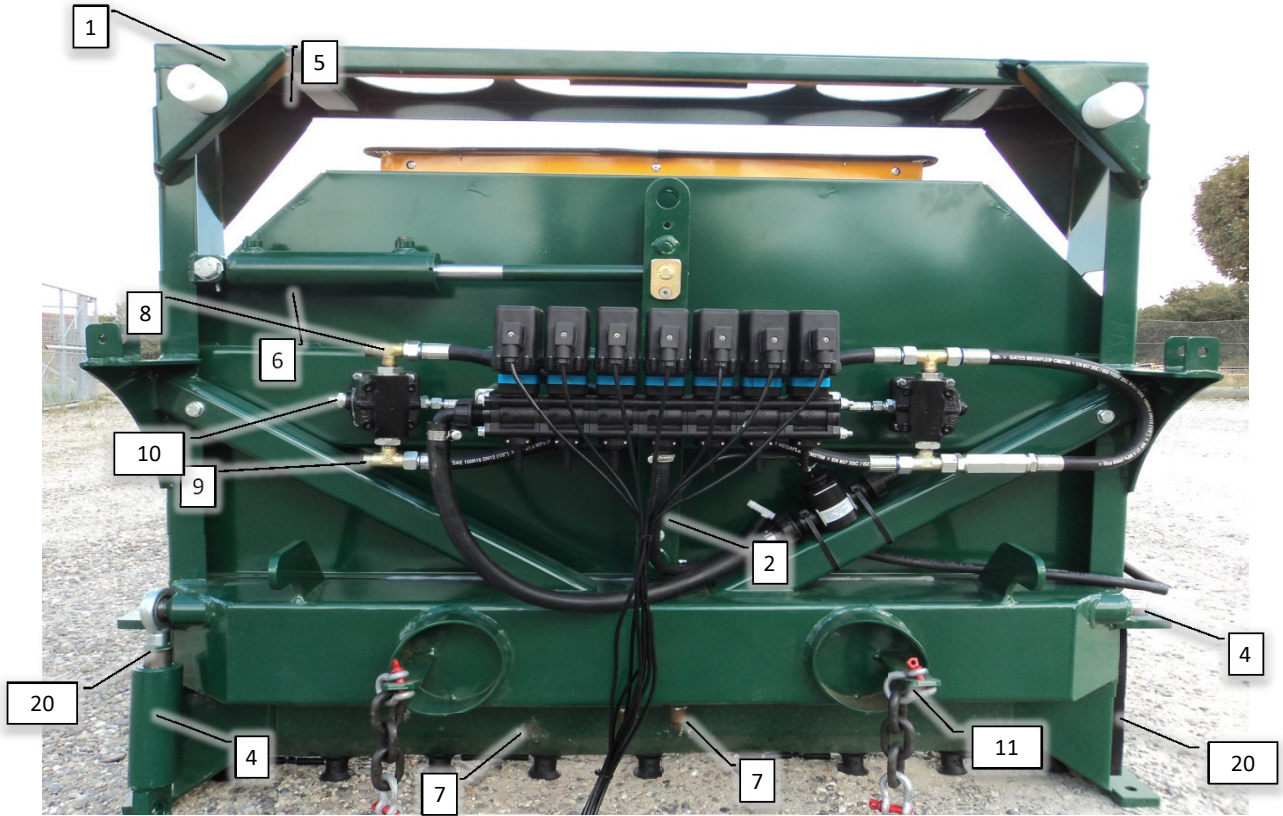

Pos	Psc	Number	Name	Price	Note
1	1	90330415	Luftfordeler CC 20-28		
2	1	90330418	Justeringsled til luftfordeler		
	1	90330013	Låsebolt un. sænk. Ø 20/70		
4	1	90330248	Støddæmper m.tallerkenfjedre AB-CC 18-28		
5	1	90214402	Gasstøddæmper vandret CC-AB		
6	1	90510358	Cylinder tilt CCII fra årg. 2012		
	1	90330102	Nagle ø30 f. pendul luftfordeler		
	1	90515098	Hy slange CCII Tiltslange 750mm		
	1	90510060	Hy brystnippel 0,5 mm		
	1	90515179	Hy slange CCII Tiltslange 600mm		
	1	90510041	Hy brystnippel 1/4' x 3/8'		
7	1	90510004	Cylinder inderbom 20-28m CC 320-5025		
	1		Pakningssæt		
	1	90210034	Bolt M10x30 FZB 8.8 ubryst		
	1	90210078	Skive M10.5x30x2.5 Plan A2		
	2	90515077	Hy slange AB CCII 1/4' LS 1600mm		
	2	90510041	Hy brystnippel 1/4' x 3/8'		
8	1	90515187	Hy slange CCII Retur blæser 950mm		
9	1	90515184	Hy slange CCII Motor slange 5900mm		
	1	90510035	Hy brystnippel 1/2' x 1/2'		
10	1	90515181	Hy slange CCII Dræn 6000mm		
	1	90510042	Hy brystnippel 3/8' BSP Male		
	1	90515182	Hy slange CCII Dræn 3500mm		
	1	90510042	Hy brystnippel 3/8' BSP Male		
	1	90510303	Hy lynkobling NV38GASM		
11	2	90210312	Kæde 3 led 13mm		
	4	90210220	Sjækkel 13 mm (7/16" x 1/2") 1,5 T		
13	1	90900041	Mærkat - eurofoil (gul) AB/CC		
14	5	90326060	Drypstop dobb. kpl. 2011		
15	8	90320083	Eurofoil forstøver kompl.		
	4	90326014	Fordeler db. sort/grå 2011-2014		
16	4	90326020	Slangeholder 16 mm enkelt WOPF		
17	1	90320083	Eurofoil forstøver kompl.		
	1	90326028	Fordeler enk. sort lige 2011-2014		
18	1	90326055	Drypstop Højre enkelt 2011		
19	1	90900058	Mærkat - Danfoil (bagend CC)		
20	1	90804243	Svampegummi Ø 200 mm		
B	1	20200190	Blæsekasse komp.		
	2	90320123	Støtteklods til luftfordeler		
	1	90340001	Slange 6,3mm - tryk		
	3	90340019	Slange 10 mm - tryk		
	2	90900080	Mærkat-advarsel-klemfare		
	2	90900084	Mærkat-advarsel-ingen ophold omkr. maski		
	4	90210085	Split 5 mm		

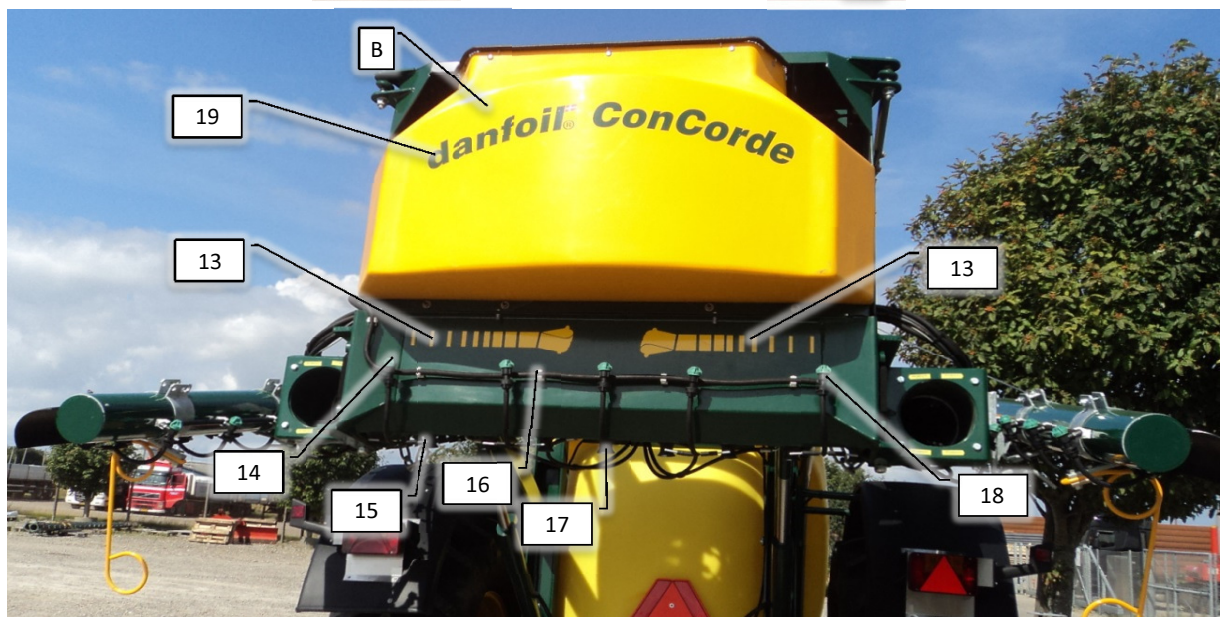

Pos	Psc	Number	Name	Price	Note
1	1	1 90330416	Luftfordeler CC 30-36m		
	2	1 90330418	Justeringsled til luftfordeler		
		1 90330013	Låsebolt un. sænk. Ø 20/70		
	3	1	Mangler		
	4	1 90330269	Støddæmper m.tallerkenfjedre AB-CC 30-36		
	5	1 90214402	Gasstøddæmper vandret CC-AB		
	6	1 90510358	Cylinder tilt CCII fra årg. 2012		
		1 90330102	Nagle ø30 f. pendul luftfordeler		
	7	1 90510295	Cylinder inderbom 36m (luftfordeler) CC		
		1	Pakningssæt		
		1 90210034	Bolt M10x30 FZB 8.8 ubrust		
		1 90210078	Skive M10.5x30x2.5 Plan A2		
		2 90515077	Hy slange AB CCII 1/4' LS 1600mm		
	8	1 90515187	Hy slange CCII Retur blæser 950mm		
	9	1 90515184	Hy slange CCII Motor slange 5900mm		
		1 90510035	Hy brystnippel 1/2' x 1/2'		
	10	1 90515181	Hy slange CCII Dræn 6000mm		
		1 90510042	Hy brystnippel 3/8' BSP Male		
		1 90515182	Hy slange CCII Dræn 3500mm		
		1 90510042	Hy brystnippel 3/8' BSP Male		
		1 90510303	Hy lynkobling NV38GASM		
	11	2 90210312	Kæde 3 led 13mm		
		4 90210220	Sjækkel 13 mm (7/16" x 1/2") 1,5 T		
	13	1 90900041	Mærkat - eurofoil (gul) AB/CC		
	14	5 90326060	Drypstop dobb. kpl. 2011		
	15	8 90320083	Eurofoil forstøver kompl.		
		4 90326014	Fordeler db. sort/grå 2011-2014		
	16	4 90326020	Slangeholder 16 mm enkelt WOPF		
	17	1 90320083	Eurofoil forstøver kompl.		
		1 90326028	Fordeler enk. sort lige 2011-2014		
	18	1 90326055	Drypstop Højre enkelt 2011		
	19	1 90900058	Mærkat - Danfoil (bagend CC)		
	20	1 90100002	Svampegummi Ø220x270x290x20 36m		
	21	1 90330286	Arm H for sidemarkeringslygter 36m		
		1 90401208	Slingerlygte Hella f. 30-36m		
		1 90330290	Mont. hængsel f/sidemark.H-36m		
	22	1 90330285	Arm V for sidemarkeringslygter 36m		
		1 90401208	Slingerlygte Hella f. 30-36m		
		1 90330291	Mont.hængsel f/sidemark.V-36m		
	23	1 60601016	Individuel Bomløft ECC 3-delt bom		
	B	1 20200190	Blæsekasse komp.		
	24	2 90320123	Støtteklods til luftfordeler		
		1 90340001	Slange 6,3mm - tryk		
		3 90340019	Slange 10 mm - tryk		
		2 90900080	Mærkat-advarsel-klemfare		
		2 90900084	Mærkat-advarsel-ingen ophold omkr. maski		
	25	1 90400130	Lygte m trekant CC venstre		
		1 90400131	Lygte med trekant CC højre		
		2 90400084	Pære 21/5W, 12 V		
		4 90400150	Pærer 12V/21W til lygter CC		
		2 90400155	Pære 12V/4W (makeringslygter airb)		
		3 90400109	Ledning 6x1 + 1x2,5 hvid		
		2 90210056	Møtrik M12 FZB låse		
		2 90210189	Bolt M20x370 FZB 8.8 AB/CC inderled		
	26	1 90330492	Nagle f/stempel bom CC II		

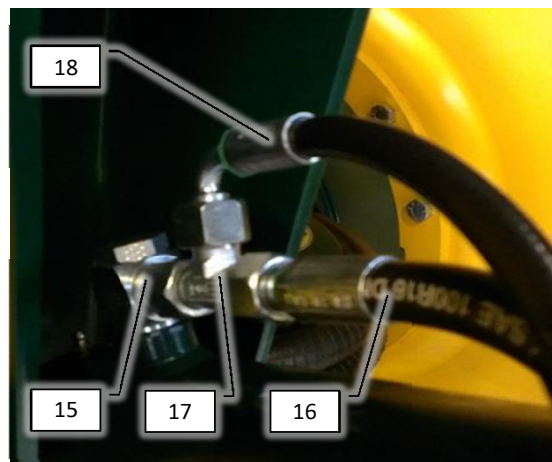
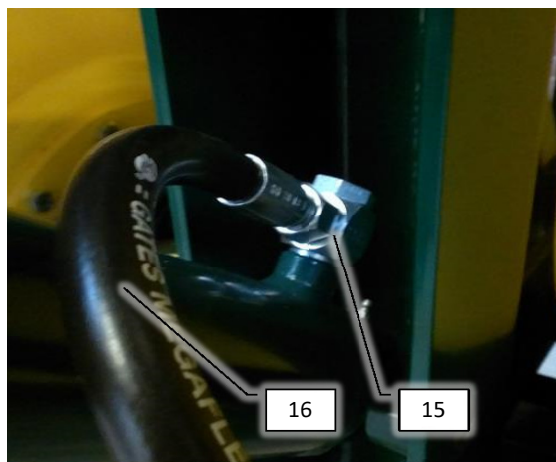
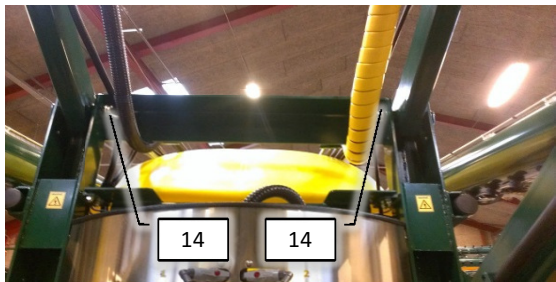
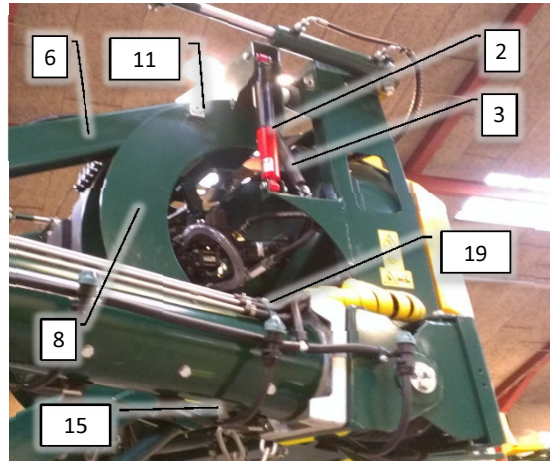
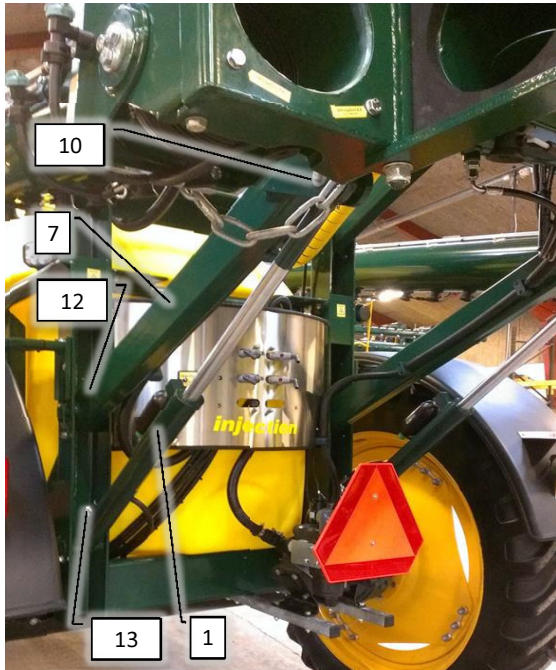

Pos	Psc	Number	Name	Price	Not Note		
2	1	1 90510356	Cylinder parallelarme 20-28m CC II				
		1 90510380	Akkumulator CC 0,35l/25 bar				
		1 90510209	Hy nippel 3/8'x12mm				
2	1	90214403	Gasstøddæmper for CC& AIRboss				
		2 90330616	Bøsning Ø15x1,5x37 AISI 304				
		2 90330617	Bøsning Ø15x1,5x16 AISI 304				
3	1	90310064	Fjeder mek. afvigerled				
		2 90210199	Øje/ringbolt 10mm el-galv				
4	1	90330417	Løfteled CC				
		1 90330102	Nagle ø30 f. pendul luftfordeler				
5	1	90310040	Rulle for slæde AB				
6	1	90330351	Parallelarm øverst CC				
7	2	90330352	Parallelarm nederst CC				
8	1	90330349	Løftekonsol CC				
9	1	90510260	Hy modulsystem 6 sek uden omløbsventil				
		12 90400170	Stik f. hyd. ventil incl. ledning 2000mm				
		1 90330287	Bøjle f. hy. ventiler (løftekonsol)				
		1 90510161	Hy Testnippel 1/4				
		1 90510043	Hy brystnippel 3/8'x1/2'				
		1 90515183	Hy slange CCII Tryk PVG/LC 5650mm				
		1 90510043	Hy brystnippel 3/8'x1/2'				
		1 90510044	Hy brystnippel 1/2'x3/4'				
		1 90510174	Hy Tee 3/4 MA/MA/FMA				
		1 90515189	Hy slange CCII Retur LC 4500mm				
		10	2	90330353	Nagle for løftecylinder CC		
		11	4	90330363	Koblingsnagle CC		
12	4	90330506	Nagle f. parallelarme				
13	2	90330492	Nagle f/stempel bom CC II				
14	2	90210200	Øje/ringbolt 12mm el-galv				
14	2	90330250	Mellemlæg f. luftfordeler/chassic 8mm				
		11 90210132	Skive M14 Galv 14x40x4 CC				
15	1	90214412	Banjo forskrning 3/8 x Ø12				
16	1	90515174	Hy slange CCII Lift 2000mm				
17	1	90510215	Hy tee 12mm				
18	1	90515122	Hy slange CCII Lift 3500mm				
19	4	90515178	Hy slange CCII Ydrebom 2300mm				
20	8	90214408	Skive M12 FZB Facet				
		6 90210162	Bolt M12x20 FZB 8.8 ubryst				
		4 90210056	Møtrik M12 FZB låse				
		4 90210210	Bolt M8x16 FZB 8.8 ubryst us indiv-6kt				
		2 90210042	Bolt M12x70 FZB 8.8 ubryst				
		2 90210343	Bolt M12x110FZB 8.8 bryst				

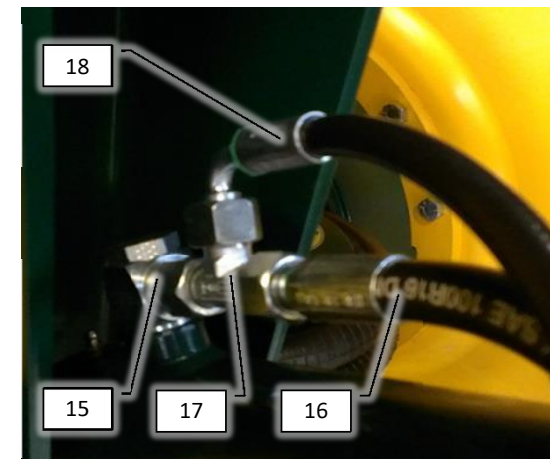
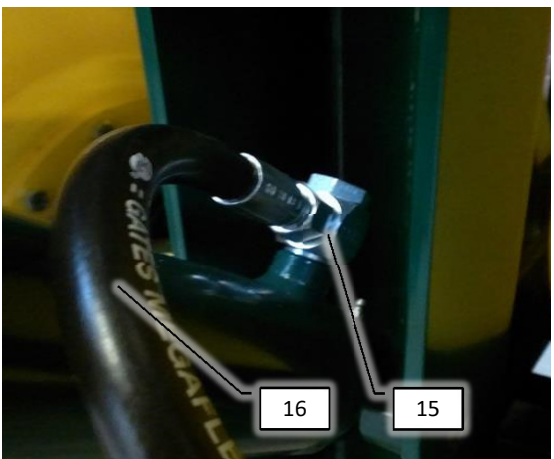
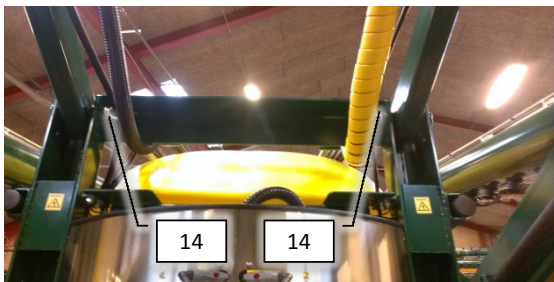
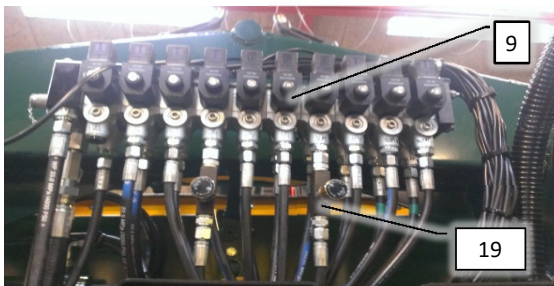
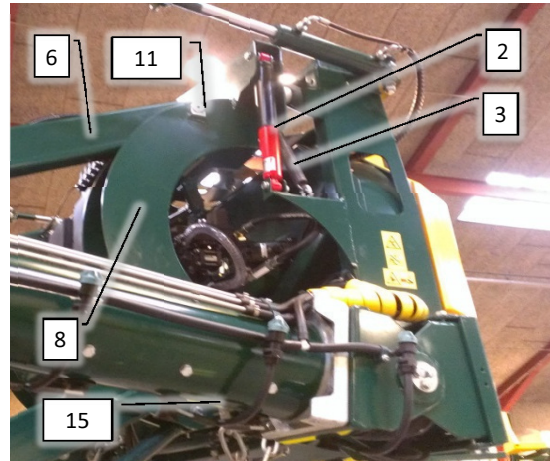
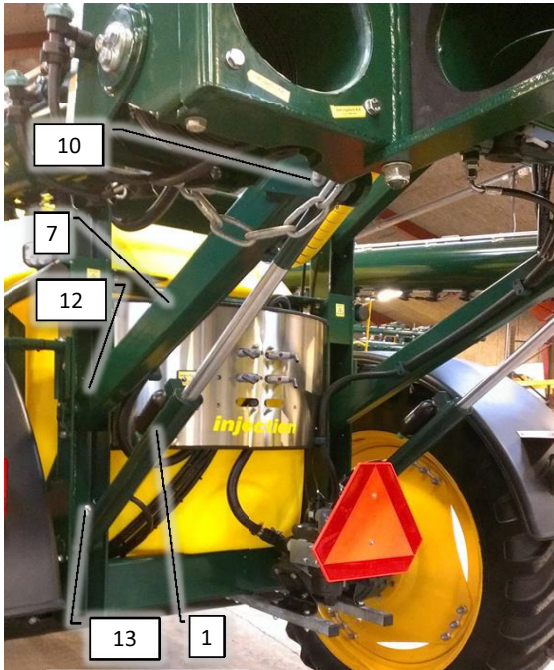

Pos	Psc	Number	Name	Price	Not Note
1	1	90510361	Cylinder parallelarme >28-36m CC II		
	1	90510380	Akkumulator CC 0,35l/25 bar		
	1	90510209	Hy nippel 3/8'x12mm		
2	1	90214401	Gasstøddæmper for CC 36mm		
3	1	90310064	Fjeder mek. afvigerled		
	2	90210199	Øje/ringbolt 10mm el-galv		
4	1	90330417	Løfteled CC		
	1	90330102	Nagle ø30 f. pendul luftfordeler		
5	1	90310040	Rulle for slæde AB		
6	1	90330351	Parallelarm øverst CC		
7	2	90330352	Parallelarm nederst CC		
8	1	90330349	Løftekonsol CC		
9	1	90510261	Hy modulsystem 8 sek uden omløbsventi CC		
	20	90400170	Stik f. hyd. ventil incl. ledning 2000mm		
	1	90330287	Bøjle f. hy. ventiler (løftekonsol)		
	1	90510161	Hy Testnippel 1/4		
	1	90510043	Hy brystnippel 3/8'x1/2'		
	1	90515183	Hy slange CCII Tryk PVG/LC 5650mm		
	1	90510043	Hy brystnippel 3/8'x1/2'		
	1	90510044	Hy brystnippel 1/2'x3/4'		
	1	90510174	Hy Tee 3/4 MA/MA/FMA		
	1	90515189	Hy slange CCII Retur LC 4500mm		
10	2	90330353	Nagle for løftecylinder CC		
11	4	90330363	Koblingsnagle CC		
12	4	90330506	Nagle f. parallelarme		
13	2	90330492	Nagle f/stempel bom CC II		
14	2	90210200	Øje/ringbolt 12mm el-galv		
14	2	90330250	Mellemlæg f. luftfordeler/chassic 8mm		
	11	90210132	Skive M14 Galv 14x40x4 CC		
15	1	90214412	Banjo forskrning 3/8 x Ø12		
16	1	90515174	Hy slange CCII Lift 2000mm		
17	1	90510215	Hy tee 12mm		
18	1	90515122	Hy slange CCII Lift 3500mm		
19	2	90510084	Hy drøvl/kontra ventil		

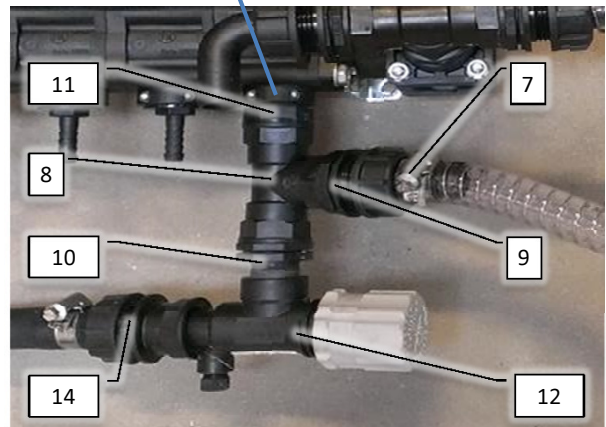
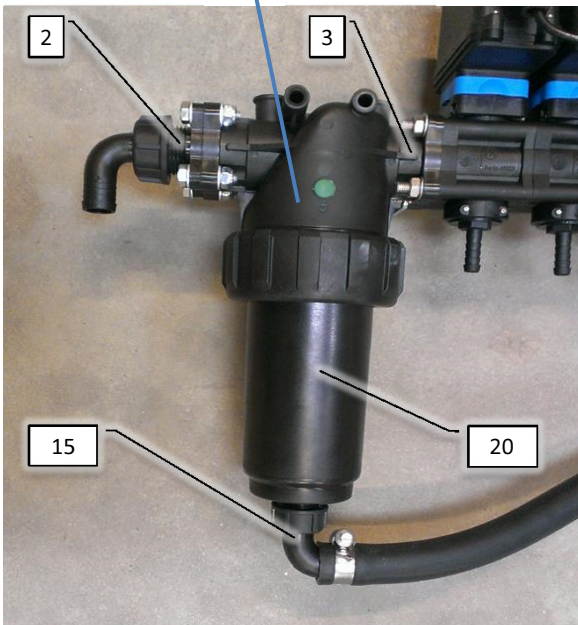
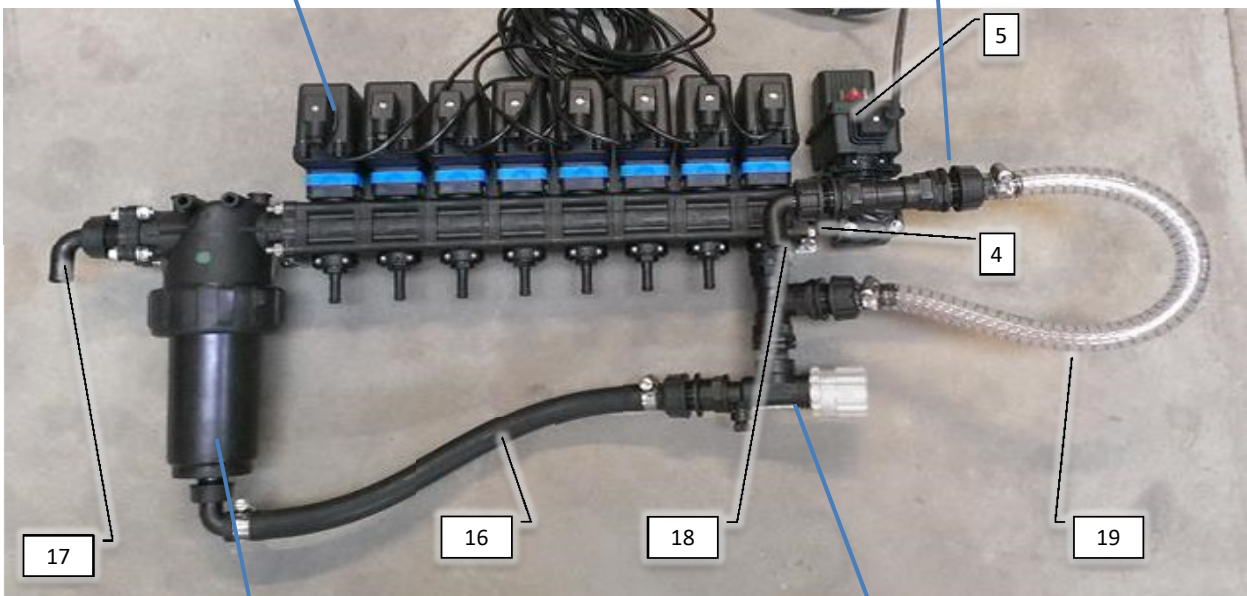
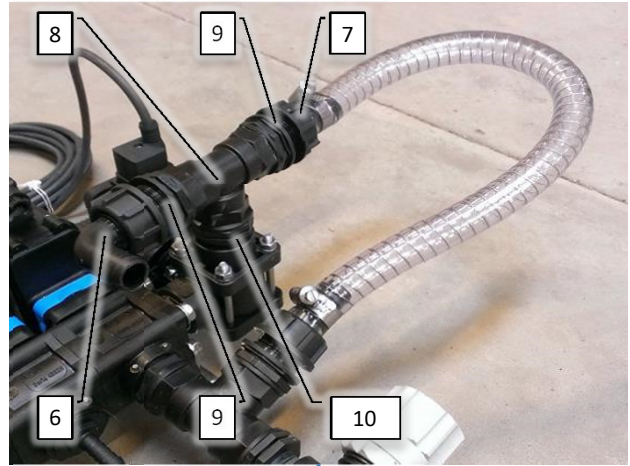

Pos	Psc	Number	Name	Price	Note
1	8	90400166	Motorventil ARAG sektion væs 10mm		
	8	90400163	Stik f. væskeventil incl. 1,3m ledning		
	8	90320145	O-ring Arag sek. ventil 39,2x2,6 Viton		
2	1	90320399	Endedæksel 1' han ARAG		
	1	90320145	O-ring Arag sek. ventil 39,2x2,6 Viton		
	4	90210030	Bolt M8x30 FZB 8.8		
	4	90210054	Møtrik M8 FZB låse		
	4	90214406	Skive M8 FZB Facet		
3	2	90320459	Beslag for væskeventil (Arag)		
	4	90320460	Stavbolte ARAG (8) L=486mm		
4	1	90320398	Endedæksel 3/4' hun ARAG		
5	1	90400300	Motorventil 3/4' (Modificeret kugle)		
	1	90400162	Kabel f. motorventil 1,5m		
6	3	90320458	Nippelreduktion G1'xG3/4' ARAG		
7	1	90320432	Slangest. G1'x20mm ARAG		
	1	90320518	Omløber G1' ARAG		
	2	90325013	O-ring G1' Arag		
8	1	90320409	T-stykke G3/4' F-F-F ARAG		
9	1	90320458	Nippelreduktion G1'xG3/4' ARAG		
10	1	90320322	Brystnippel G3/4' ARAG		
11	1	90320479	Studs 3/4" f/ARAG motorventil		
12	1	90320124	Overtryksventil (væske) 3/4'		
13	1	90325102	UDG: Nippelmuffe G1'xG3/4'		
14	1	90320432	Slangest. G1'x20mm ARAG		
15	1	90320433	Slangest. G3/4'x20mm 90G ARAG		
	1	90320429	Omløber G3/4' ARAG		
	2	90325024	O-ring G3/4' Arag NBR		
	1	90210186	Spændebånd 20-32/12- C7 W3		
16	0,8	90340004	Slange 19 mm - tryk		
17	1	90320434	Slangest. G1'x20mm 90G ARAG		
	1	90320518	Omløber G1' ARAG		
	2	90325013	O-ring G1' Arag		
	3	90340004	Slange 19 mm - tryk		
18	1	90320335	Slangest. G1'x25mm 90G ARAG		
	1	90320518	Omløber G1' ARAG		
	2	90325013	O-ring G1' Arag		
	3	90340044	Slange 25 mm sug		
19	0,5	90340049	Slange 20mm Alfasteel m. stålspiral		
20	1	90320410	Filterhus kpl m. flanger ARAG tryk		

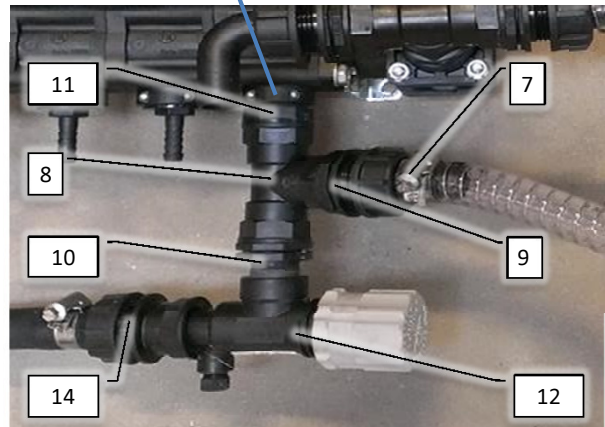
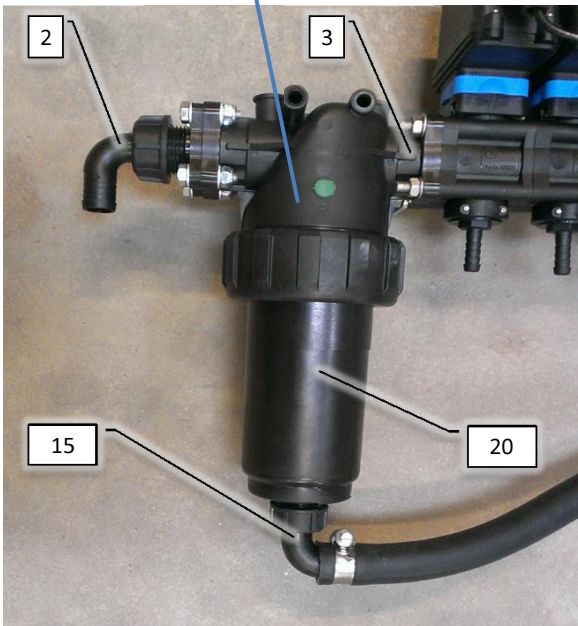
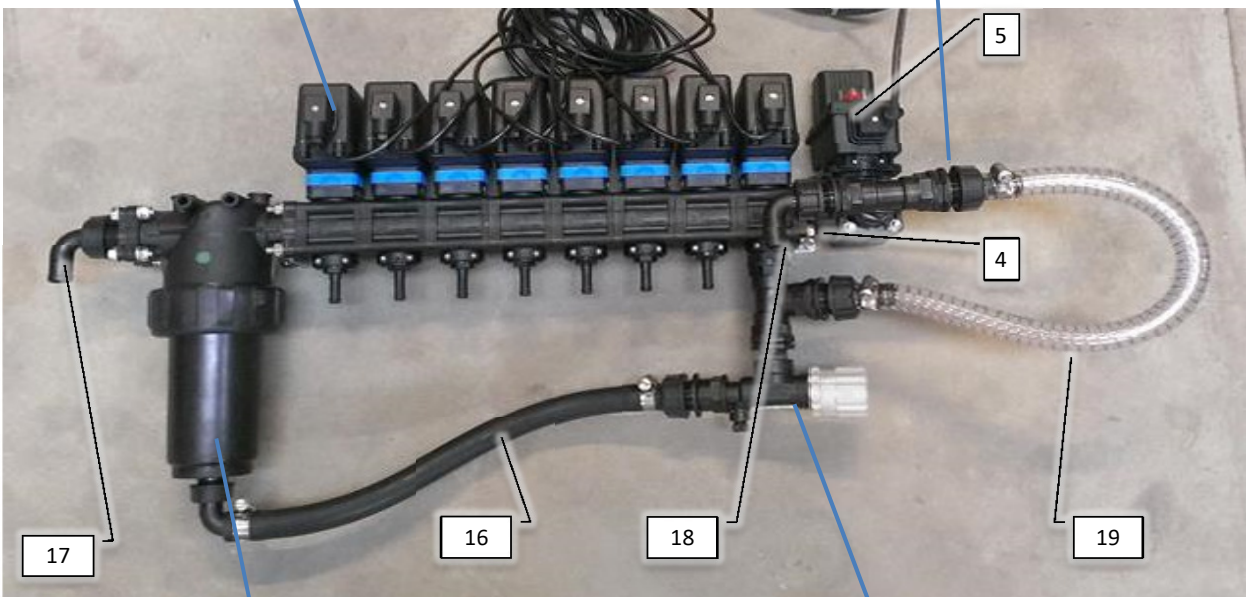
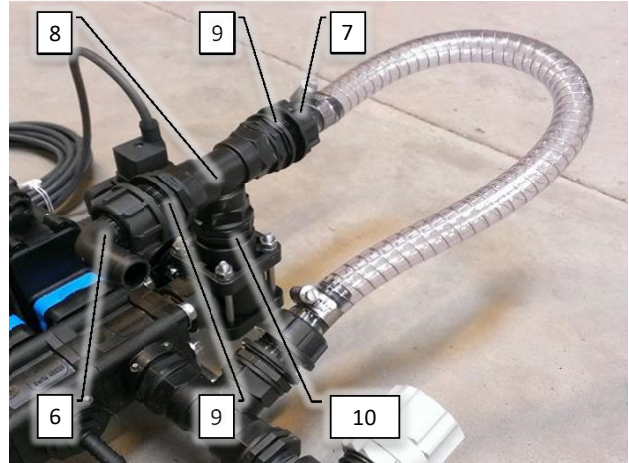
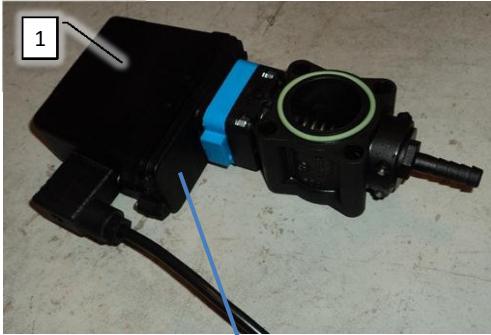

Pos	Psc	Number	Name	Price	Note
1	10	90400166	Motorventil ARAG sektion væs 10mm		
		90400163	Stik f. væskeventil incl. 1,3m ledning		
		90320145	O-ring Arag sek. ventil 39,2x2,6 Viton		
2	1	90320399	Endedæksel 1' han ARAG		
		90320145	O-ring Arag sek. ventil 39,2x2,6 Viton		
		90320434	Slangest. G1'x20mm 90G ARAG		
		90320518	Omløber G1' ARAG		
		90325013	O-ring G1' Arag		
		90210186	Spændebånd 20-32/12- C7 W3		
3	2	90320459	Beslag for væskeventil (Arag)		
		90320487	Stavbolte ARAG (10) L=610mm		
4	1	90320398	Endedæksel 3/4' hun ARAG		
5	1	90400300	Motorventil 3/4' (Modificeret kugle)		
		90400162	Kabel f. motorventil l,5m		
6	3	90320458	Nippelreduktion G1'xG3/4' ARAG		
7	1	90320432	Slangest. G1'x20mm ARAG		
		90320518	Omløber G1' ARAG		
		90325013	O-ring G1' Arag		
		90210186	Spændebånd 20-32/12- C7 W3		
8	1	90320409	T-stykke G3/4' F-F-F ARAG		
9	1	90320458	Nippelreduktion G1'xG3/4' ARAG		
10	1	90320322	Brystnippel G3/4' ARAG		
11	1	90320479	Studs 3/4" f/ARAG motorventil		
12	1	90320124	Overtryksventil (væske) 3/4'		
13	1	90325102	UDG: Nippelmuffe G1'xG3/4'		
14	1	90320432	Slangest. G1'x20mm ARAG		
15	1	90320433	Slangest. G3/4'x20mm 90G ARAG		
		90320429	Omløber G3/4' ARAG		
		90325024	O-ring G3/4' Arag NBR		
		90210186	Spændebånd 20-32/12- C7 W3		
16	0,8	90340004	Slange 19 mm - tryk		
17	3	90340004	Slange 19 mm - tryk		
18	3	90340044	Slange 25 mm sug		
19	0,5	90340049	Slange 20mm Alfasteel m. stålspiral		
20	1	90320410	Filterhus kpl m. flanger ARAG tryk		

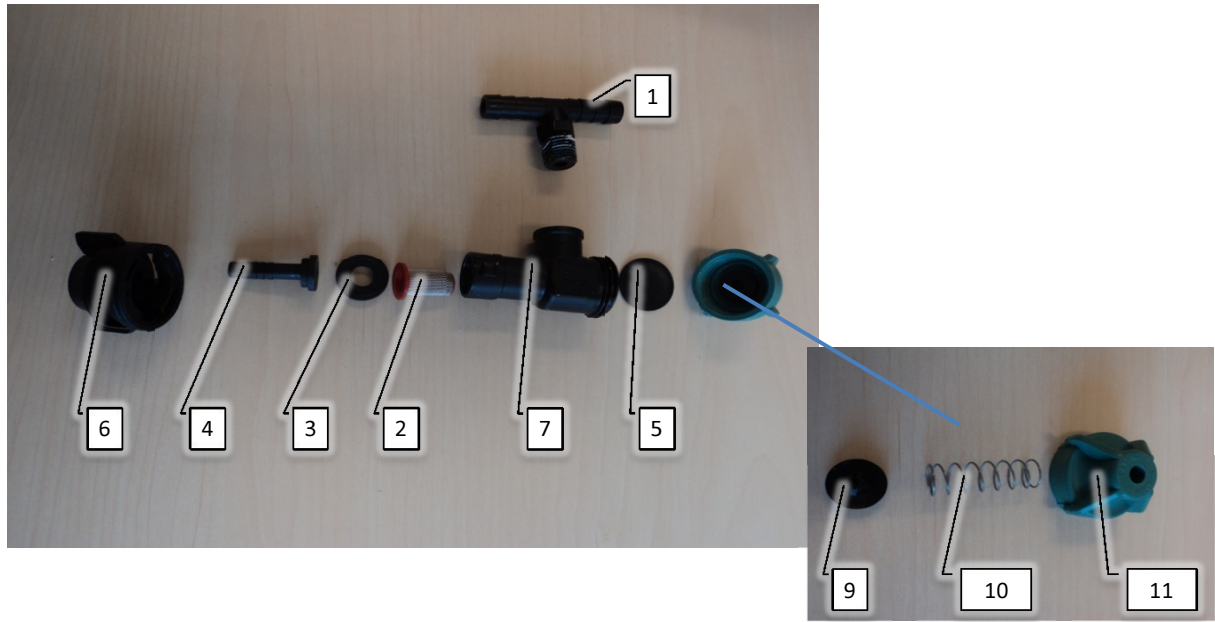

Pos	Psc	Number	Name	Price	Note
1	1	90326010	T-stykke 1/4' x 10m/m		
2	1	90326002	Filter f/ drypstop		
3	1	90326003	Pakning f/ drypstop		
4	1	90326004	Dysenippel 6 mm f. drypstop		
5	1	90326005	Membran f/ drypstop		
6	1	90326009	Kap f/ drypstop/pakning		
7	1	90326018	Hus t/drypstop		
8	1	90326030	Top t/drypstop samlet (grøn/sort)		
9	1	90326016	Tap til Top drypstop		
10	1	90326019	Fjeder t/drypstop		
11	1	90326027	top t/drypstop (grøn RAL6024)		

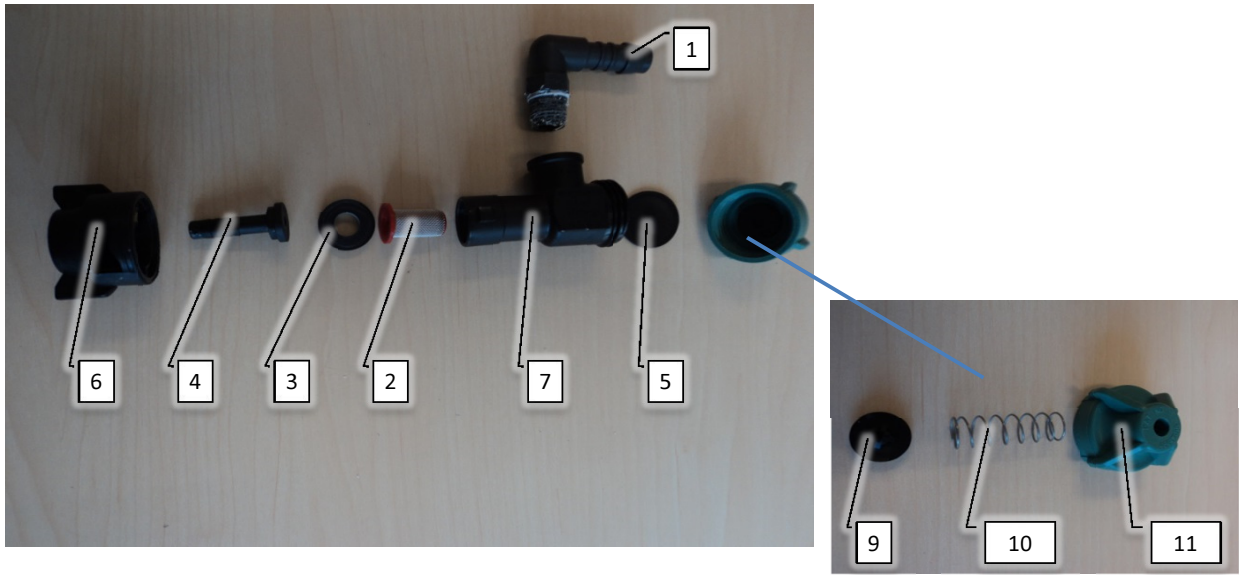

Pos	Psc	Number	Name	Price	Note
1	1	90320130	Slangeforsk.1/4"x10x90° Norma		
2	1	90326002	Filter f/ drypstop		
3	1	90326003	Pakning f/ drypstop		
4	1	90326004	Dysenippel 6 mm f. drypstop		
5	1	90326005	Membran f/ drypstop		
6	1	90326009	Kap f/ drypstop/pakning		
7	1	90326018	Hus t/drypstop		
8	1	90326030	Top t/drypstop samlet (grøn/sort)		
9	1	90326016	Tap til Top drypstop		
10	1	90326019	Fjeder t/drypstop		
11	1	90326027	top t/drypstop (grøn RAL6024)		

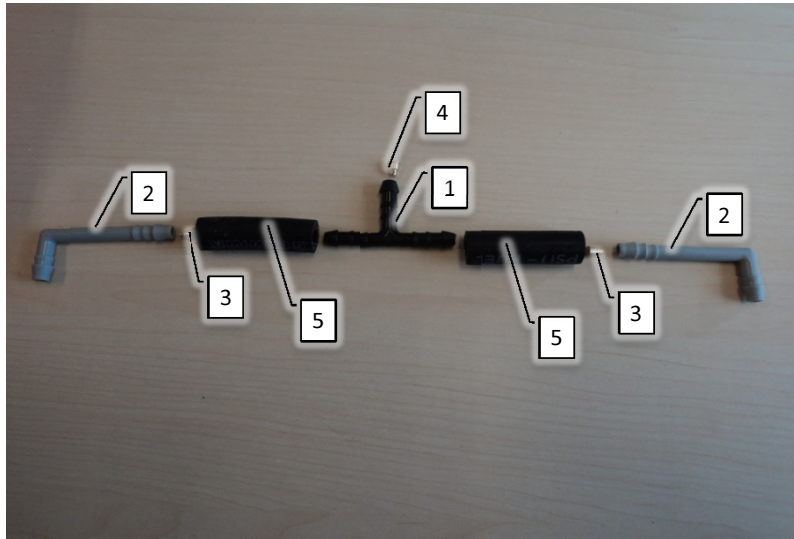

Pos	Psc	Number	Name	Price	Note
1	1	90320065	T-slangestuds 6 mm		
2	1	90320207	Vinkel t/forstøver 6 mm Grå		
3	1	90326007	Drøvle TJ 0,5		
4	1	90326008	Drøvle TJ 0,7		
5	0,1	90340001	Slange 6,3mm - tryk		

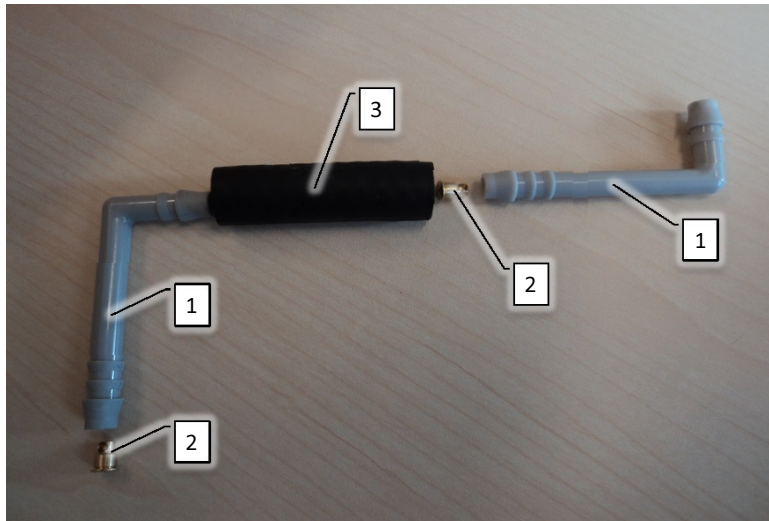

Pos	Psc	Number	Name	Price	Note
1	2	90320207	Vinkel t/forstøver 6 mm Grå		
2	2	90326007	Drøvle TJ 0,5		
3	0,05	90340001	Slange 6,3mm - tryk		

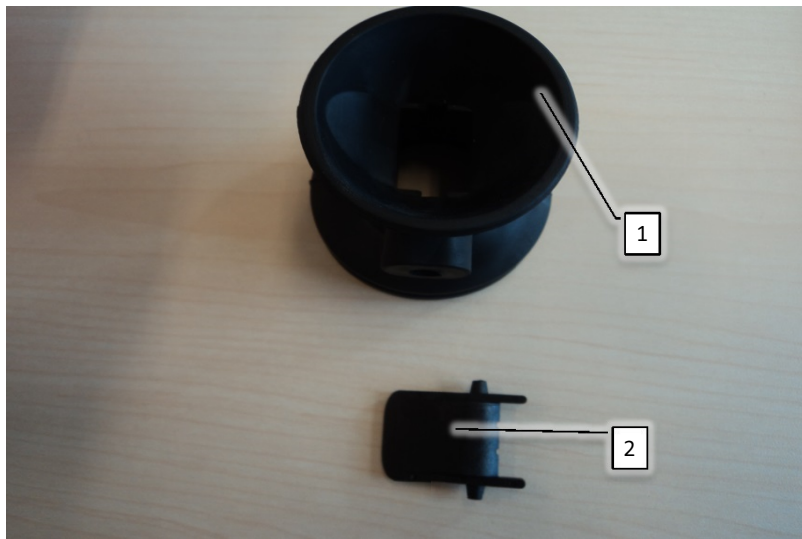

Pos	Psc	Number	Name	Price	Note
1	1	90320077	Eurofoil forstøver hus		
2	1	90320078	Eurofoil forstøverplade (afrundet kant)		



Pos	Psc	Number	Name	Price	Note
1	1	90404612	Print injektion t/1 stk. pumpe kpl.		
1	1	60604500	Tank Inj. 28 l. u/omrør		
	1	90404614	Kalibreringsbox injektion		
	1	90404615	Inj. kalibreringsboxs (komp. Kabel)		
	1	90900160	Mærkat "kalibreringsbox injection"		
	1	90900175	Mærkat - danfoil injektion-Middel 1-3		
A	1	60604120	Injectionsskab basis slet 20200160		



Pos	Psc	Number	Name	Price	Note
1	1	90404613	Print injektion t/2 stk. pumper kpl.		
	1	60604505	Tank Inj. 28 l. m/omrør		
	1	60604515	Tank Inj. 100 l. m/omrør		
	1	90900071	Mærkat - tankskala injektdunk 100L		
	1	90404614	Kalibreringsbox injektion		
	1	90404615	Inj. kalibreringsboxs (komp. Kabel)		
	1	90900160	Mærkat "kalibreringsbox injection"		
	2	90900175	Mærkat - danfoil injektion-Middel 1-3		
	1	90404635	Box t/print Lykketr. med låg		
A	1	60604120	Injectionsskab basis slet 20200160		
B	1	60604115	Tilkoblingsstuds expander til rensesyste		



Pos	Psc	Number	Name	Price	Note
1	1	90404613	Print injektion t/2 stk. pumper kpl.		
2	1	90404612	Print injektion t/1 stk. pumpe kpl.		
		1 60604500	Tank Inj. 28 l. u/omrør		
		1 60604505	Tank Inj. 28 l. m/omrør		
		1 60604515	Tank Inj. 100 l. m/omrør		
		1 90900071	Mærkat - tankskala injektdunk 100L		
		1 90404614	Kalibreringsbox injektion		
		2 90404615	Inj. kalibreringsboxs (komp. Kabel)		
		1 90900160	Mærkat "kalibreringsbox injection"		
		3 90900175	Mærkat - danfoil injektion-Middel 1-3		
A	1	60604120	Injectionsskab basis slet 20200160		
B	1	60604115	Tilkoblingsstuds expander til rensesyste		
		20200160	Injectionsskab basis		



Pos	Psc	Number	Name	Price	Note
1	2	90404613	Print injektion t/2 stk. pumper kpl.		
	1	60604500	Tank Inj. 28 l. u/omrør		
	1	60604505	Tank Inj. 28 l. m/omrør		
	2	60604515	Tank Inj. 100 l. m/omrør		
	2	90900071	Mærkat - tankskala injektdunk 100L		
	1	90404614	Kalibreringsbox injektion		
	2	90404615	Inj. kalibreringsboxs (komp. Kabel)		
	1	90900160	Mærkat "kalibreringsbox injection"		
	4	90900175	Mærkat - danfoil injektion-Middel 1-3		
	1	90404635	Box t/print Lykketr. med låg		
A	1	20200160	Injectionsskab basis		
B	1	60604115	Tilkoblingsstuds expander til rensesyste		
C	1	60604114	Tilkoblingsstuds til renses20200150		



Pos	Psc	Number	Name	Price	Note
1	2	90404613	Print injektion t/2 stk. pumper kpl.		
2	1	90404612	Print injektion t/1 stk. pumpe kpl.		
	1	60604500	Tank Inj. 28 l. u/omrør		
	2	60604505	Tank Inj. 28 l. m/omrør		
	2	60604515	Tank Inj. 100 l. m/omrør		
	2	90900071	Mærkat - tankskala injektdunk 100L		
	1	90404614	Kalibreringsbox injektion		
	3	90404615	Inj. kalibreringsboxs (komp. Kabel)		
	1	90900160	Mærkat "kalibreringsbox injection"		
	5	90900175	Mærkat - danfoil injektion-Middel 1-3		
A	1	20200160	Injectionsskab basis		
B	1	60604115	Tilkoblingsstuds expander til rensesyste		
C	1	60604114	Tilkoblingsstuds til renses20200150		



Pos	Psc	Number	Name	Price	Note
1	1	90404613	Print injektion t/2 stk. pumper kpl.		
	2	60604500	Tank Inj. 28 l. u/omrør		
	2	60604505	Tank Inj. 28 l. m/omrør		
	2	60604515	Tank Inj. 100 l. m/omrør		
	2	90900071	Mærkat - tankskala injektdunk 100L		
1	1	90404614	Kalibreringsbox injektion		
	3	90404615	Inj. kalibreringsboxs (komp. Kabel)		
	1	90900160	Mærkat "kalibreringsbox injection"		
	1	90400022	El-samlebox f. injektion		
	6	90900175	Mærkat - danfoil injektion-Middel 1-3		
A	1	20200160	Injectionsskab basis		
B	1	60604115	Tilkoblingsstuds expander til rensesyste		
C	1	60604114	Tilkoblingsstuds til renses20200150		

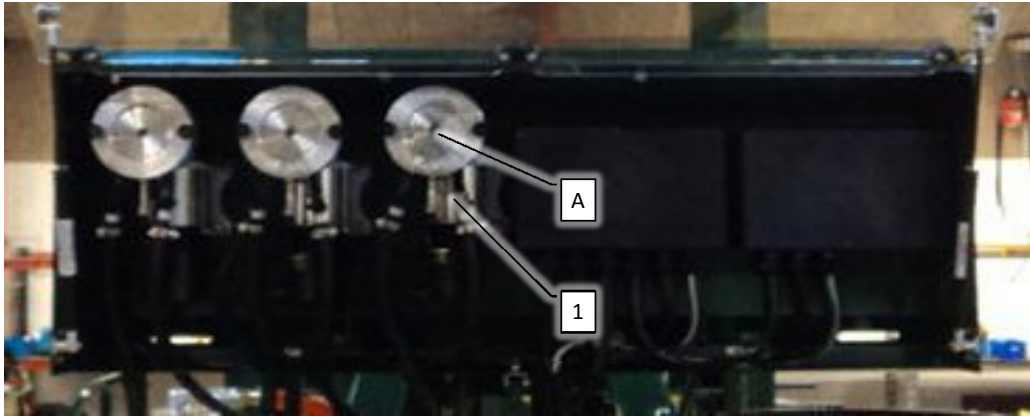

Pos	Psc	Number	Name	Price	Note
1	1	90407207	Motor f/injektionspumpe lille (ny versio		
A	1	60604059	Injektionspumpe basis		

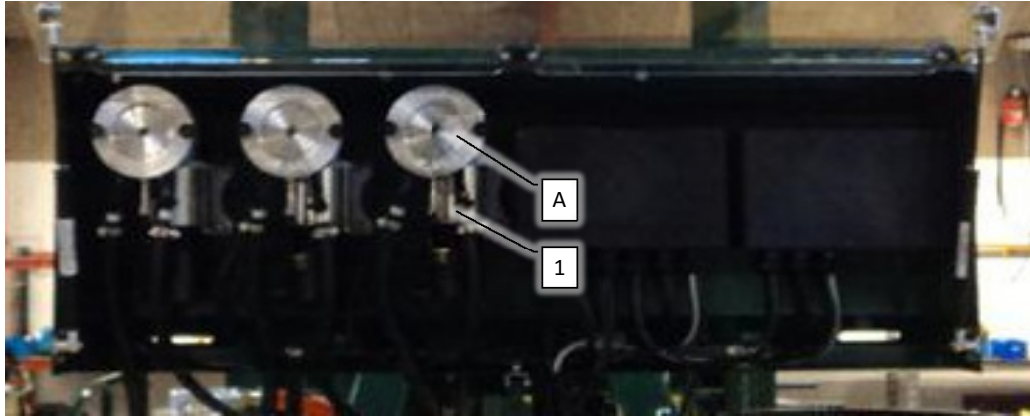

Pos	Psc	Number	Name	Price	Note
1	1	90407206	Motor f/injektionspumpe stor (ny version		
A	1	60604059	Injektionspumpe basis		

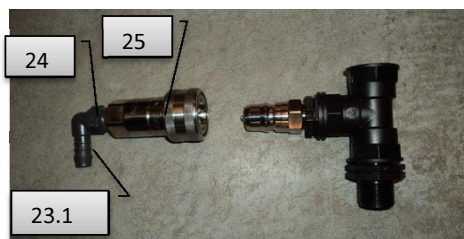
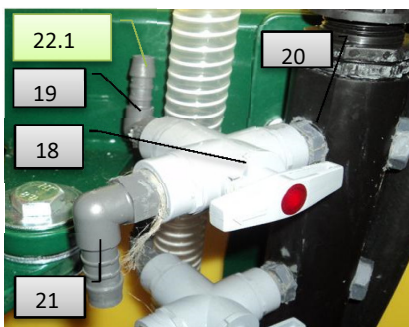
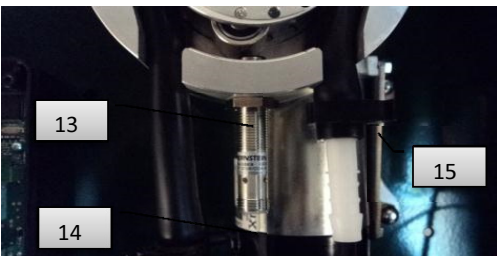
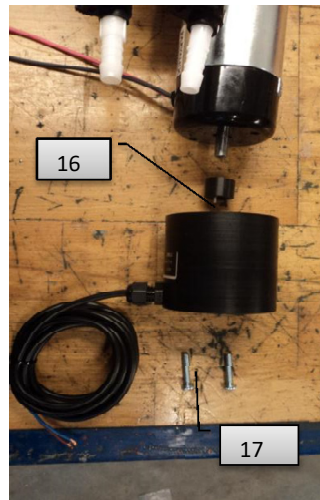
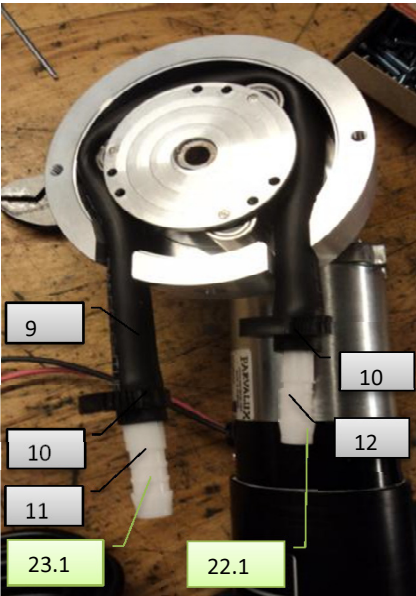
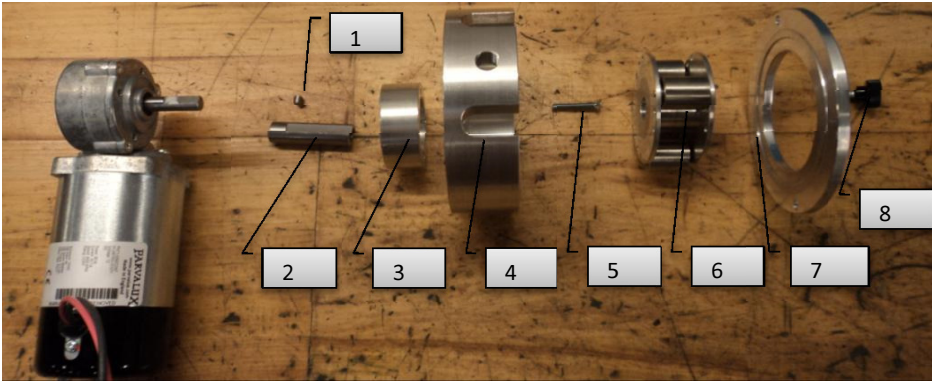

Pos	Psc	Number	Name	Price	Note
1	1	Mangler			
2	1	Mangler			
3	1	Mangler			
4	4	90337210	pumpehus f/injektionsmotor ny		
5	1	90214418	Bolt M5x30 FZB 8.8 unsæ. umbr.		
6	1	Mangler			
7	1	Mangler			
8	1	Mangler			
9	1	90340042	Slange ED plex 3/8' peristaltisk pumpe		
10	1	90210105	Spændebånd/clips PVC		
11	1	90320248	Slangesamler GRS 12-10 mm		
		1 90210104	UDG: Spændebånd 12-22/9- C7 W3 (90210088		
12	1	90320249	Slangesamler GS 10 mm		
		1 90210104	UDG: Spændebånd 12-22/9- C7 W3 (90210088		
13	1	90403710	Induktiv føler t/injektion CCII		
14	1	90403703	Hjulføler ledning 2m induktiv		
15	1	90330300	Monteringsbeslag f/gearmotor		
		2 Mangler			
		2 Mangler			
16	1	90404621	Spændingsgenerator injekt. ny motor		
17	2	Mangler			
18	1	90320273	Kuglehane 3/8' 3-vejs		
19	1	90320199	Slangeforsk.3/8"x10x90°Norma		
		1 90210088	Spændebånd 12-22/9 C7 W3		
20	1	90320297	Brystnippel 3/8' x 3/8'		
21	1	90320477	Slangeforsk.3/8"x12x90°Norma		
22	4	Mangler			
23	4	Mangler			
24	1	90320291A	Slangeforsk.1/2"x12x90°Norma		
		1 90210088	Spændebånd 12-22/9 C7 W3		
25	1	90320389	Lynkobling hun 1/2' t/injekt		

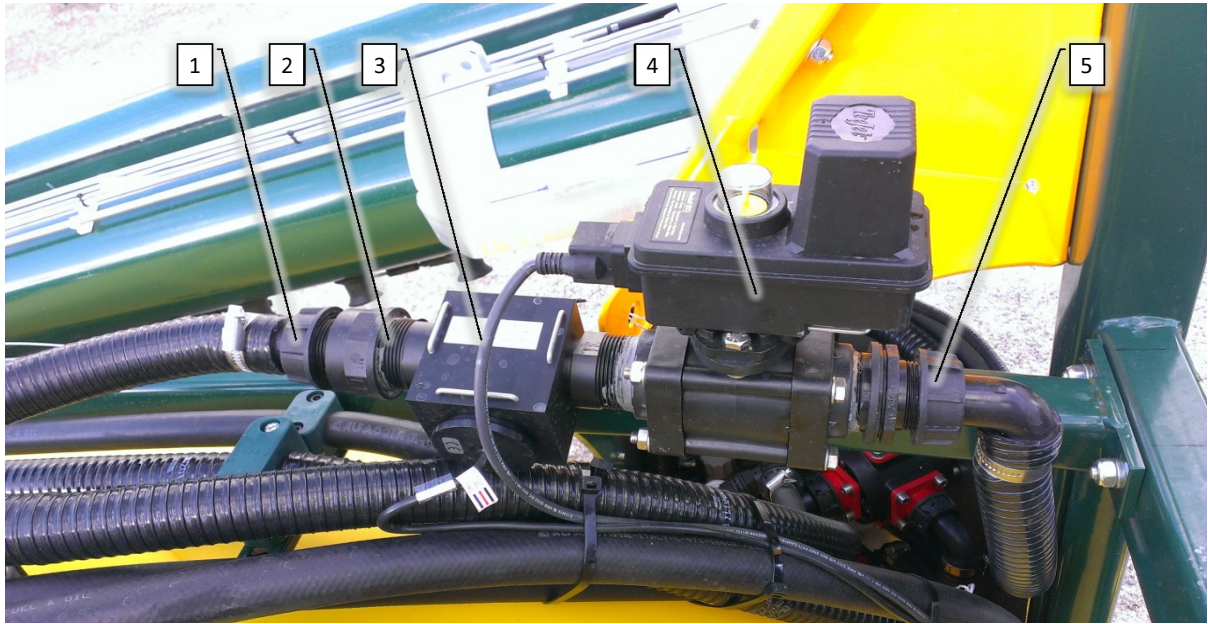

Pos	Psc	Number	Name	Price	Note
1	1	1 90105010	Mont.sæt f/traktor PC styring std.		
		1 90320513	Omløber G1 1/4' ARAG		
	2	1 90320264	Spidsmuffe G1 1/2'xG1 1/4' ARAG		
	3	1 90334801	Konsol fylde flowmåler 95mm bred		
		1 90400013	Gevindstuds Ø 26x1 500udv g		
		1 90400016	Flowmåler Ø26 6m fyldeflowmål		
	4	1 90400026	Motorventil t.fyldeflowmåler		
		1 90400161	Kabel f motorventil 6m		
	1	1 90320453	Nippelreduktion G1 1/2'xG1 1/4' ARAG		
		2 90320513	Omløber G1 1/4' ARAG		
		1 90320531	UDG:Slangest. G1 1/4'x32mm 90G		



Pos	Psc	Number	Name	Price	Note
1	1	90330512	Standard Platform f/ inj. tanke ECC II		
	5	90210034	Bolt M10x30 FZB 8.8 ubrust		
2	1	90330308	Bådsurringsæt 3 m- 25mm sort		

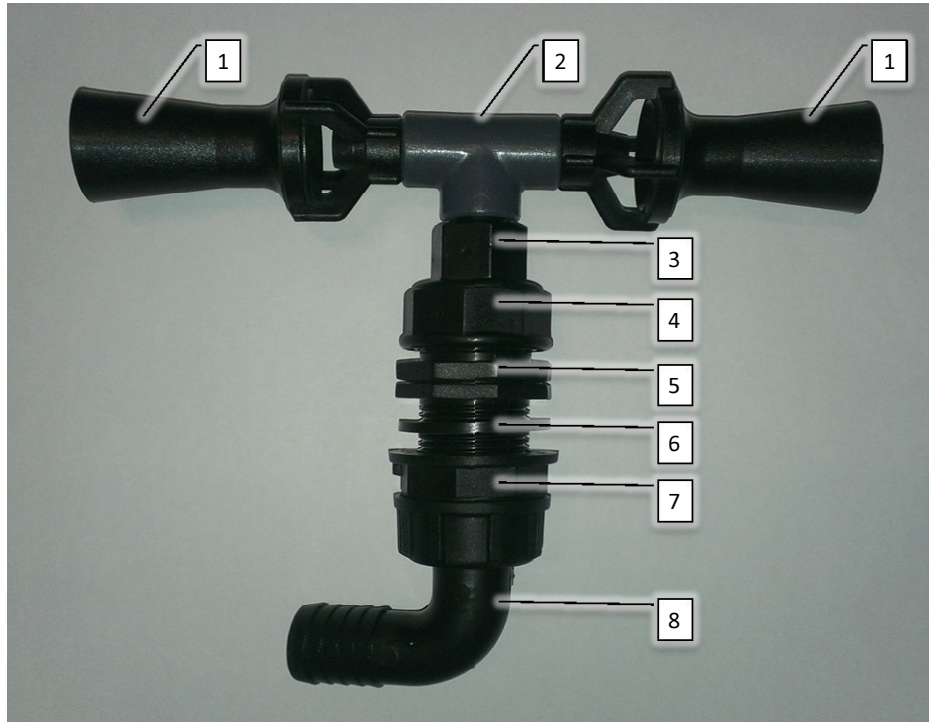

Pos	Psc	Number	Name	Price	Not Note
1	2	90320046	Jet-agitator (omrører)		
2	1	90320256	T-stykke 3/8'		
3	1	90320293	Spidsmuffe G1/2'xG3/8' ARAG		
4	1	90320087	Spidsmuffe G1'xG1/2' ARAG		
5	1	90320025	Brystnippel G1' lang ARAG		
6	1	90320027	Pakning for G1' omløber, tankg. ARAG		
7	1	90320026	Bagmøtrik G1' ARAG		
8	1	90320335	Slangest. G1'x25mm 90G ARAG		
		1 90320518	Omløber G1' ARAG		
		2 90325013	O-ring G1' Arag		
		1 90210186	Spændebånd 20-32/12- C7 W3		

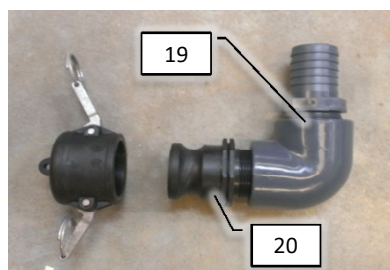
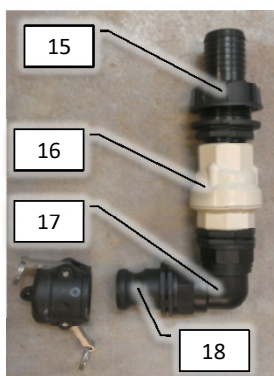
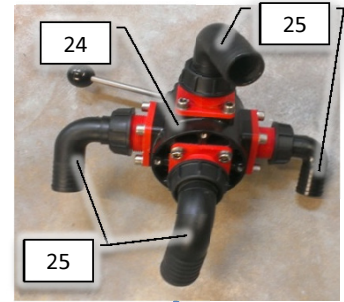
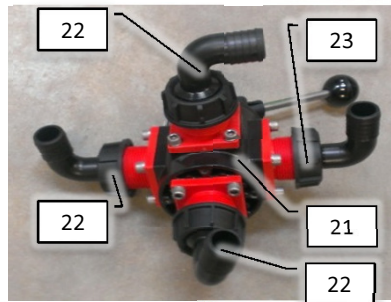
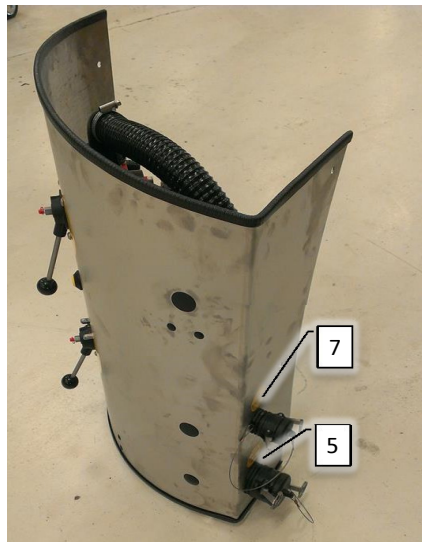
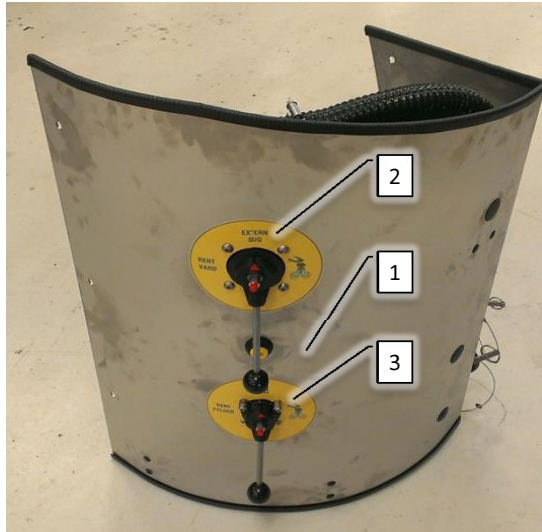

Pos	Psc	Number	Name	Price	Note
1	1	90330400	Filterplade CC rustfri		
	2	90330067	Kantliste til luftkasse CC & AB		
2	1	90900048	Mærkat- filter/kemifylder CC-AB DK		
3	1	90900060	Mærkat - filter/rengøring CC DK		
5	1	90900067	Mærkat - filter/extern sug CC		
7	1	90900073	Mærkat - Påfyldning		
	2	90330516	Beslag f. filterplade/motorventil		
15	1	90320503	Slangest. G1 1/4'x32mm ARAG		
	1	90320513	Omløber G1 1/4' ARAG		
16	1	90325100	Nippelreduktion G1 1/4'xG1' ARAG		
	1	90320400	Kontraventil rent vand 1'		
	1	90325061	Brystnippel G1' ARAG		
17	1	90320454	Vinkel G1 90G F-F ARAG		
18	1	90320036	Lynkobling TypeF M1'xMG1'		
	1	90320047	Lynkobling TypeH Prop 1'		
	0,1	90211105	Wire rustfri 1,5mm AISI 316 syrefast		
19	1	90320231	Vinkel 1 1/2' grå		
	1	90320235	Slangeforsk.1 1/2"x40mm		
	1	90320328	Lynkobling TypeF M1 1/2'xMG1 1/2'		
	0,75	90340008	Slange 38 mm sug		
20	1	90320329	Lynkobling TypeH Prop 1 1/2'		
	0,1	90211105	Wire rustfri 1,5mm AISI 316 syrefast		
21	1	90320165	Ventil Polmac 4-vejs stor		
22	1	90320532	Slangest. G1 1/2'x40mm 90G ARAG		
		90325063	Omløber G1 1/2' ARAG		
23	1	90320531	UDG:Slangest. G1 1/4'x32mm 90G		
	1	90320513	Omløber G1 1/4' ARAG		
24	1	90320166	Ventil Polmac 4-vejs lille AB sug/CC tryk		
25	1	90320504	Slangest. G1 1/4'x25mm 90G ARAG		
	1	90320513	Omløber G1 1/4' ARAG		

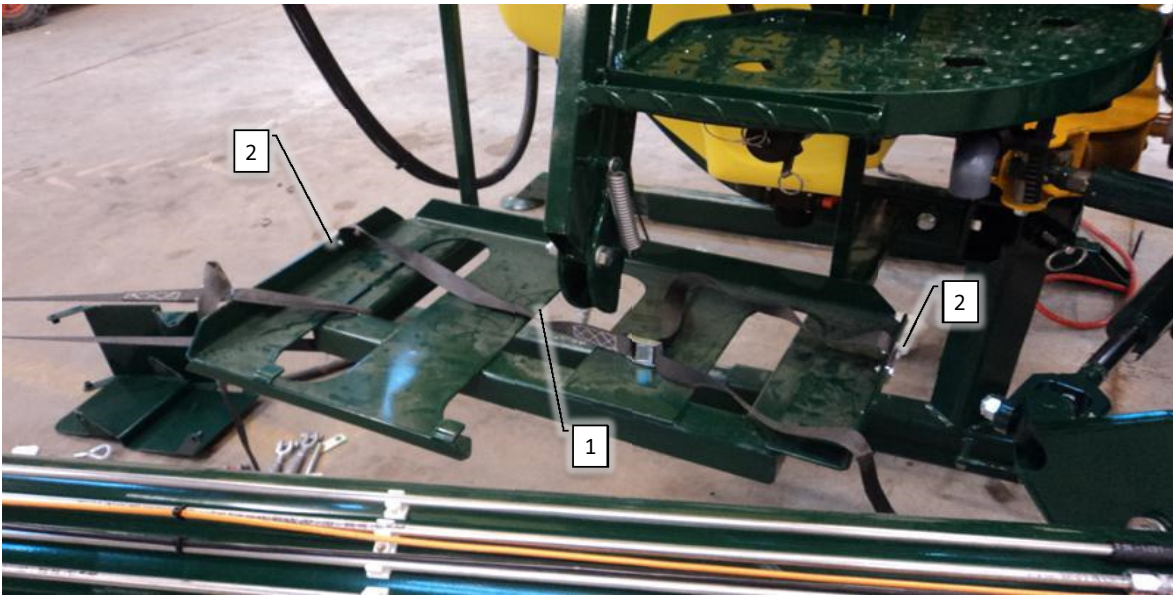

Pos	Psc	Number	Name	Price	Note
1	1	90214106	Båndsurring 5 m- 25mm sort 500kg		
2	1	90330399	Laskeplade lille CC		
	2	90210002	Bolt M6x20 FZB 8.8 ubryst		
	4	90214405	Skive M6 FZB Facet		
	2	90210053	Møtrik M6 FZB låse		



Pos	Psc	Number	Name	Price	Note
1	1	90404600	PC-Spray Controller V1		
2	1	90404617	Montagekugle PC (RAM 1 ½")		
3	1	90404618	Montagearm PC (RAM)		
4	1	90105011	Mont.sæt f/traktor PC styring INJ.		
5	1	90404607	PC<->Joystick (komp. Kabel 4x0,75)		
6	1	20200008	Reservedelspose i køletaske DK		
8	1	BRUGERV.	Brugervejledning		

danfoil®

Jellingvej 14 | DK-9230 Svenstrup J

Tlf. +45 98 67 42 33

www.danfoil.dk | info@danfoil.dk

