



Spare Parts Catalogue  
danfoil AirBoss

**danfoil**®  
- less is more...



**Hovednummer:**  
+45 98 67 42 33

**Vagttелефон: (april til oktober):**  
+45 40 43 12 33

**Fax:**  
+45 98 67 34 88

**E-mail:**  
[info@danfoil.dk](mailto:info@danfoil.dk)

**Adresse:**  
danfoil a/s  
Sjællandsvej 8  
DK-9670 Løgstør  
[www.danfoil.dk](http://www.danfoil.dk)

**Servicepartner**  
**TBS Maskinpower A/S**  
Ørderup Kirkevej 43  
6520 Toftlund  
Tlf. 75 38 11 22  
[www.tbs.dk](http://www.tbs.dk)

**Snertinge Maskinforretning A/S**  
Skelbæk 12  
4460 Snertinge  
Tlf. 59 26 80 04  
[www.s-mf.com](http://www.s-mf.com)

Se [www.danfoil.dk](http://www.danfoil.dk) for komplet forhandlerliste for Danmark.

**Norge**  
**AGRITEKNIKK AS**  
V/ Geir Arne Skyrud  
Østgården  
NO-2265 Namnå  
Tlf. +47 46842610  
[geir@agriteknikk.no](mailto:geir@agriteknikk.no)

**Sverige**  
**Håkan Svegrup**  
Reservelede/Service/Test  
Vindbackgården  
SE-241 92 Eslöv  
Tlf. +46 (0)708924116  
[hs@danfoil.dk](mailto:hs@danfoil.dk)

**Finland**  
**Suomen Yrittäjien Maatalous OY**  
Alhoniituntie 4  
FIN-01900 Nurmijärvi  
Tlf. +358 92764 550  
Fax. +358 92764 5555

**Tyskland/Schweiz**

**Land und Baumaschinen Service AG**  
Brühlstrasse 7  
CH-4107 Ettingen  
Tlf. +41 61722 0655  
Fax. +41 61722 0658  
[info@lubs.ch](mailto:info@lubs.ch)

Kontakt danfoil på  
+45 98 67 42 33 eller  
[info@danfoil.dk](mailto:info@danfoil.dk)

**Estland**  
**Starfeld OÜ**  
Aretuse 7  
Märje Täthvere Vald  
EE-61406 Tartumaa  
Tlf. +372 (0)7346855  
[www.starfeld.ee](http://www.starfeld.ee)

**Litauen**  
**Technikos tiekimo kompanija UAB**  
Azuolytes g. 2  
LT-37176 Panevezys  
Tlf. +370 61451213  
[www.ttk.lt](http://www.ttk.lt)

**Øvrige Europa**  
Kontakt danfoil på  
+45 98 67 42 33 eller  
[info@danfoil.dk](mailto:info@danfoil.dk)

#### DK

Ret til ændringer i priser og specifikationer uden varsel forbeholdes. Ligeledes tages forbehold for trykfejl.  
I øvrigt gælder almindelige salgs- og leveringsbetingelser for danfoil a/s.  
Eftermontering af udstyr pålægges monteringsomkostninger.  
Der tillægges et gebyr på 150,- kr. på ordre under netto 500,-kr.  
Denne prisliste annullerer alle tidligere prislister og er gyldig fra 01.09.2013.  
Priser i DKK, ab fabrik (Incoterms 2010), Excl. Moms

#### ENG

The company reserves the right to alter its prices and any specifications at any time.  
The prices are based on present exchange rate.  
Conditions of Sale are "General Conditions for Sales and Delivery" for danfoil a/s.  
Mounting of extra equipment after delivery will be charged  
For orders below DKK 500,- a fee for DKK 150,- will be added  
All previous lists cancelled. This price list is effective from 1<sup>st</sup> of September 2013.  
Prices EXW (Incoterms 2010), exclude VAT and taxes.

Psc	Pos	Psc	Number	Name	Price	Note
			Forside AB 20	Forside AB		1
			20200034	Basis Std. Airboss 2013		2
			20200043	Hovedramme komplet AB		3
			20200037	Slæde AB		4
			90330248	Støddæmper m.tallerkenfjedre AB-CC 18-28		5
			20200038	Mont. Bomløft-cylinder AB		6
			20200044	Hydraulikkomponenter AB		7
			20200014	PVG 32 ventil klargjort AB		8
			20200013	Modulsystem 6 sekt klargjort t/AB		9
			20200015	Tank 1000L Std. montage AB		10
			20200010	Rentvandstank Std. 80L AB klargjort		11
			20200017	Håndvasktank 16L AB klargjort		12
			20200045	Luftfordeler AB 2013		13
			20200180	Mellemleds sæt		14
			20200190	Blæsekasse komp.		15
			20200035	Sek.-ventiler 7 sek. AB 2013		16
			20200011	Trykfilter modul Std. AB		17
			20200005	Væskepumpesystem Std. AB		18
			20200003	Betjeningspanel Std. AB		19
			20200046	Styring basis std. AB		20
			20200047	Mærkater basis std. AB		21
			90400184	Kabel f. væskeventiler 7 sek. AB		22
			20200050	Dele f. montering på traktor std. AB-CC		23
			20200004	Kemifylder klargjort AB		24
			20200120	Trinbræt AB		25
			90510130	Hy slangesæt f / AB komplet		26
			20200009	Slange t/væskesystem AB		27
			90326055	Drypstop Højre enkelt 2011		28
			90326014	Fordeler db t/ forstøv sort/grå Tysk/ny		29
			90326015	Fordeler t/ forst.enk. grå/grå Tysk/ny		30
			90320083	Eurofoil forstøver kompl.		31
			90326060	Drypstop dobb. kpl. 2011		32

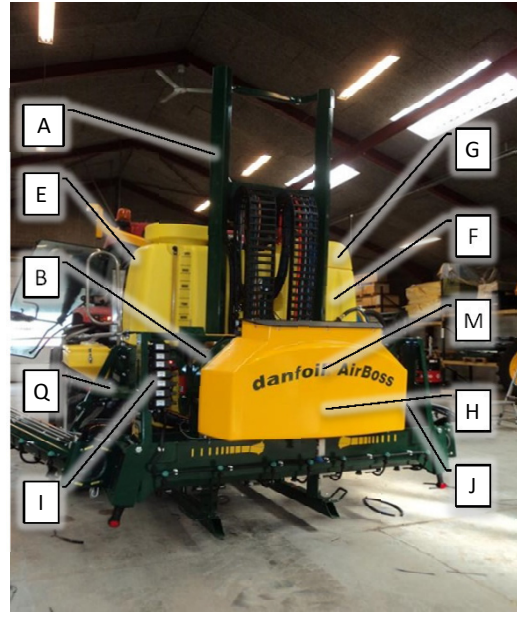
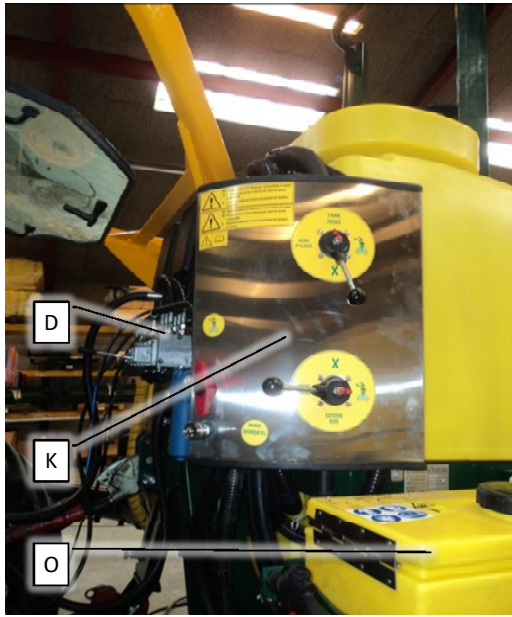

Pos	Psc	Number	Name	Price	Note
A	1	20200043	Hovedramme komplet AB		
B	1	20200037	Slæde AB		
C	1	20200038	Mont. Bomløft-cylinder AB		
D	1	20200044	Hydraulikkomponenter AB		
E	1	20200015	Tank 1000L Std. montage AB		
F	1	20200010	Rentvandstank Std. 80L AB klargjort		
G	1	20200017	Håndvasktank 16L AB klargjort		
H	1	20200045	Luftfordeler AB 2013		
I	1	20200035	Sek.-ventiler 7 sek. AB 2013		
J	1	20200005	Væskepumpesystem Std. AB		
K	1	20200003	Betjeningspanel Std. AB		
L	1	20200046	Styring basis std. AB		
M	1	20200047	Mærkater basis std. AB		
O	1	20200004	Kemifylder klargjort AB		
P	1	20200011	Trykfilter modul Std. AB		
Q	1	20200120	Trinbræt AB		
R	1	20200009	Slange t/væskesystem AB		
S	1	90510130	Hy slangesæt f / AB komplet		

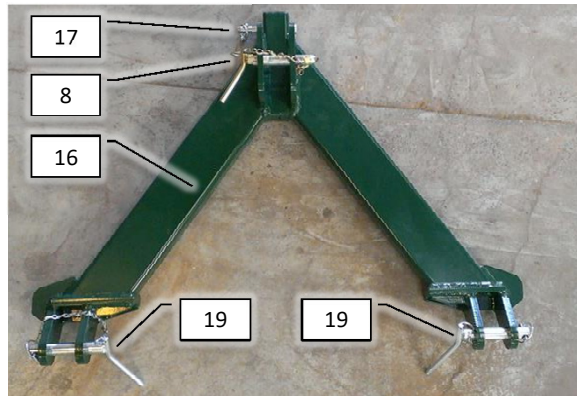
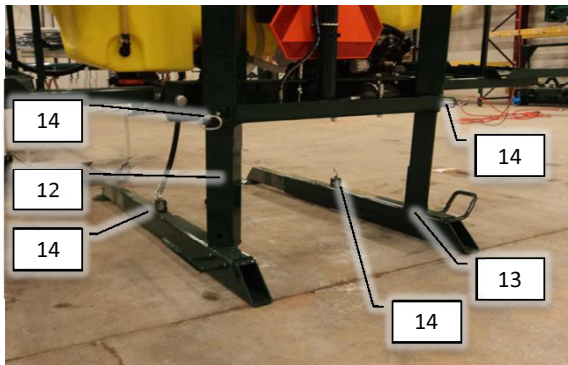

Pos	Psc	Number	Name	Price	Note
1	1	90330440	Tårnprofil AB		
2	1	90330439	Bagvange svejst for AB		
3	1	60604053	Plade f. magnetlabels		
	2	90210219	Bolt M6x16 FZB buttonhead		
4	1	90400145	Lygte for EAB V		
5	1	90400096	Trekantrefleks		
	1	90330608	Monteringsbeslag trekantrefleks AB		
6	1	90400146	Lygte for EAB H		
7	2	90320112	Kæde for hydraulikslange igus		
	1	90320546	Tværbjælke t. Igus kæde		
	1	90320544	Led t. top (m. tap) Igus kæde		
	1	90320545	Led t. bund (m. hul) Igus kæde		
8	1	90330433	Bomstøtte AB		
9	2	90330430	Bomholder AB		
10	2	90320806	Prop 70x40x4 Air Boss		
11	1	90330438	Hovedramme for AB		
12	1	90330446	Støttefod V for AB		
13	1	90330447	Støttefod H for AB		
14	1	90334016	Lås for støttefod BAWA		
15	1	90330448	Fodforlænger svejst for AE		
16	1	90330025A	A-ramme traktordel		
17	1	90330087	Pig ø19x102 f. lås A-ramme		
18	1	90330010	Pig for A ramme/træk CC 25x130mm		
20	1	90320543	Kam t. Igus kæde		
A	1	90400147	Kabelsæt til lygte EAB		

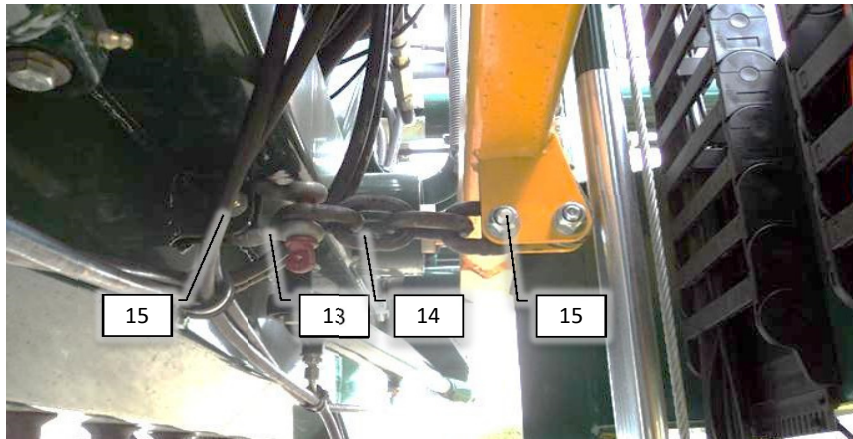
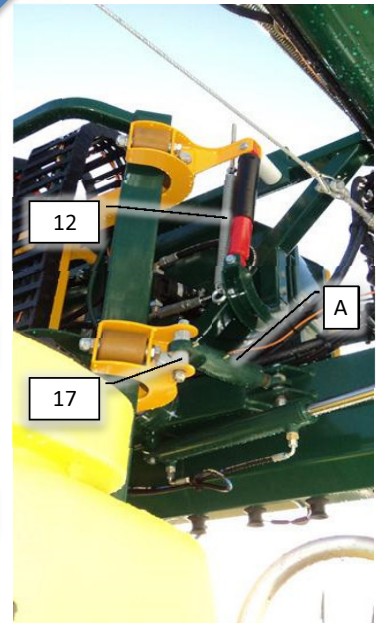
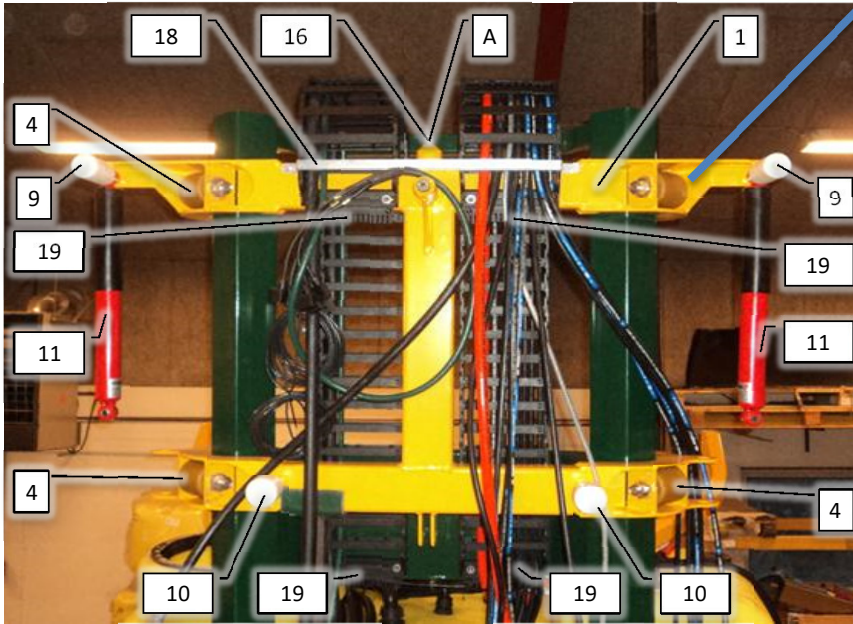
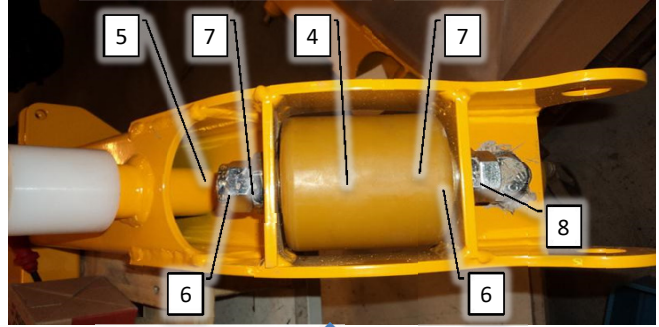
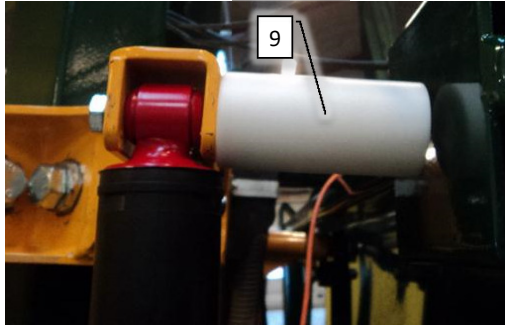



Pos	Psc	Number	Name	Price	Note
1	1	90330444	Slæde for AB		
4	2	90310040	Ruller for slæde AB		
5	2	90210069	Møtrik M20 FZB låse		
6	4	90330443	Justermøtrik for slæderulle AB		
7	4	90210077	Skive M20 FZB Facet		
8	2	90210264	Bolt M20x150 FZB 8.8 bryst		
9	1	90330441	Støtteklods top for AB		
		1 90210056	Møtrik M12 FZB låse		
		2 90214408	Skive M12 FZB Facet		
		1 90210044	Bolt M12x90 FZB 8.8 bryst		
10	1	90332422	Støtteklods bund AB 2013		
11	2	90214403	Gasstøddæmper for CC& AIRboss		
12	2	90310053	Fjeder f. bomstabilisator AB		
		4 90230011	Møtrik M12 FZB		
		2 90214408	Skive M12 FZB Facet		
		2 90330611	Fjederstrammer 190mm		
13	1	90210116	Sjækkel 16mm (1/2') Crosby		
14	0,2	90210171	Kæde 13 mm Luftfordeler		
15	1	90210056	Møtrik M12 FZB låse		
		1 90210039	Bolt M12x50 FZB 8.8 ubryst		
		2 90214408	Skive M12 FZB Facet		
16	1	90210026	Bolt M10x20 FZB 8.8 ubryst		
		1 90210208	Skive M12 13x37x3 A2 Skærm		
17	2	90330557	Bøsning Ø33,7x2x37mm AISI 304 rør		
		1 90210284	Expanderbolt kpl. Ø25x154		
18	1	90336955	Holder for IGUS kæde		
		2 90210231	Bolt M10x16 FZB 8.8 bryst		
		2 90214407	Skive M10 FZB Facet		
19	1	90320543	Kam t. Igus kæde		
		2 90210244	Bolt M6x20 FZB buttonhead		
		2 90214405	Skive M6 FZB Facet		
A	1	90330248	Støddæmper m.tallerkenfjedre AB-CC 18-28		



Pos	Psc	Number	Name	Price	Note
1	1	90330358	Støddæmperhus svejst CC/AB		
	1	90330359	Gevindprop CC 2'		
	1	90330360	Stempelstang svejst CC		
	2	90210129	Smørenippel lige 6 mm		
	1	90210071	Møtrik M24 FZB låse		
	32	90210138	Tallerkenfjeder DIN 2093B 2mm		
	1	90210319	Møtrik M24x2,0 FZB Kontra		
	1	90510412	Ledleje Ø25/24x2,0 udv. gevind		

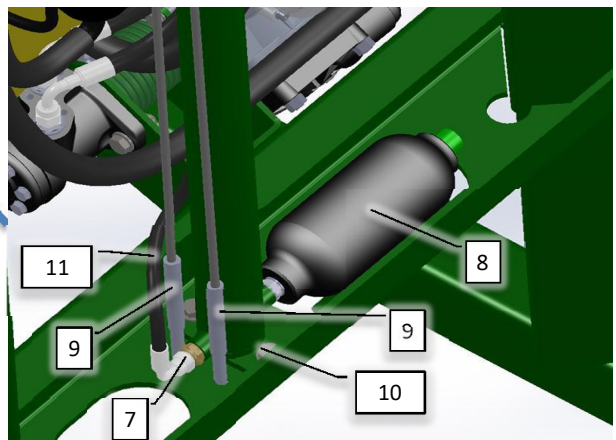
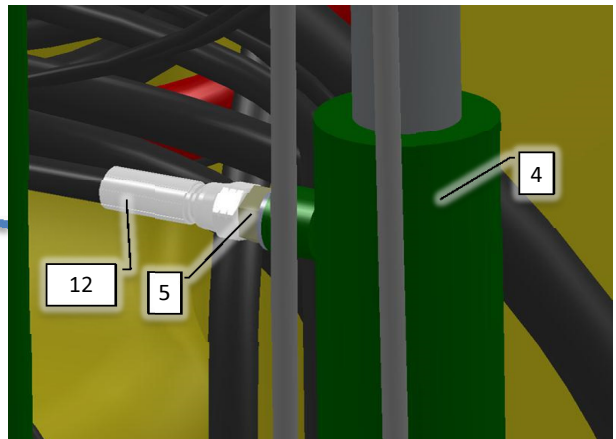
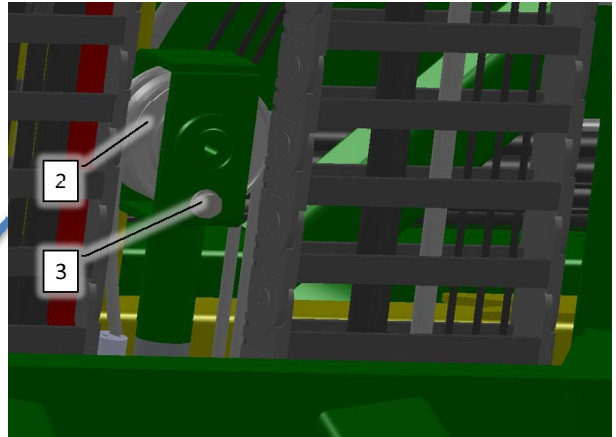

Pos	Psc	Number	Name	Price	Note
2	1	90330540	Wirehjul dobbelt AB		
	1	90330102	Nagle ø30 f. pendul luftfordeler		
	2	90403431	Leje 6206-2RS		
2.1	1	90317640	Wirehjul enkelt AB		
		90330455	Bolt M22x100 FZB 8.8 f.Wirehjul		
3	1	90210026	Bolt M10x20 FZB 8.8 ubryst		
	1	90214407	Skive M10 FZB Facet		
4	1	90510410	Cylinder til dobbelt Wirehjul AB		
	1	90510025	Hy pakn.Sæt 50/35 Liftcyl AB 1-hjul		
	1	90510508	Hy Pakningssæt ny liftcyl.AB 2-hjul		
5	1	90510041	Hy brystnippel 1/4' x 3/8'		
	1	90510056	Bonded seal hydr. 3/8'		
7	1	90510314	Slangebrudsventil 3/8"		
	1	90510056	Bonded seal hydr. 3/8'		
	1	90510209	Hy nippel 3/8"x12mm		
8	1	90510155	Akkumulator f bomaffjed. AB, 0,7 l/25bar		
	1	90510409	Bonded seal hydr. M18		
	1	90510269	Hy brystnippel 3/8"x18mm		
	1	90510056	Bonded seal hydr. 3/8'		
9	1	90214089	Wire for lift slæde		
	1	90210056	Møtrik M12 FZB låse		
	1	90214408	Skive M12 FZB Facet		
9.1	1	90214430	Wire for lift slæde AB - Før 2013		
10	2	90210216	Bolt M12x35 FZB 8.8 bryst skaffe		
	2	90210056	Møtrik M12 FZB låse		
	2	90214408	Skive M12 FZB Facet		
11	1	90515075	Hy slange 1/4 lift 1100 AB		
12	1	90515074	Hy slange 1/4'lift 2200 AB		

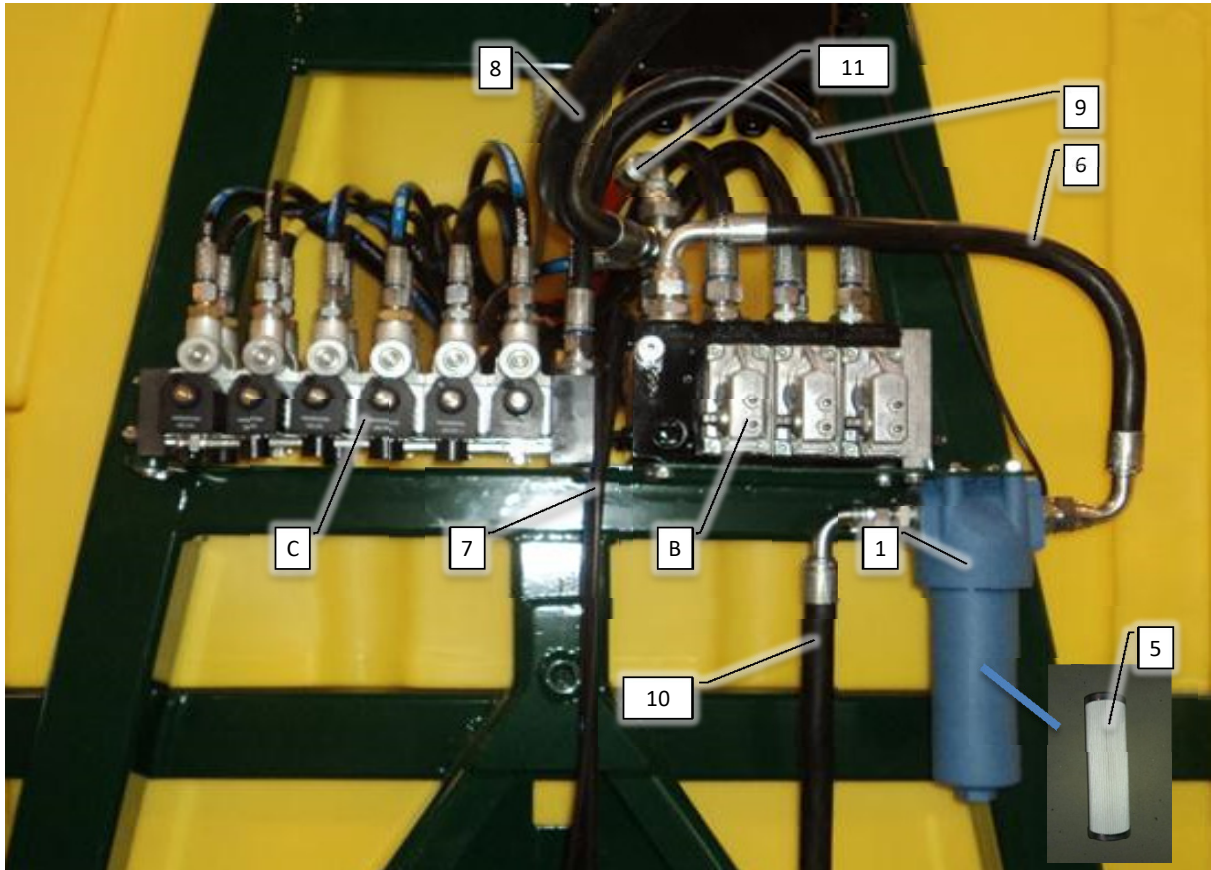

Pos	Psc	Number	Name	Price	Note
1	1	90510051	Mahle filter PI3608+PI1108		
5	1	90510148	Hy filterelement tryk (Mahle)		
2	15	90510400	Olie textran TDH premium		
4	1	90510129	Fittingsæt AB		
6	1	90515083	Hy slange 5/8' filter 550 AB		
7	1	90515077	Hy slange AB CCII 1/4' LS 1600mm		
8	1	90515085	Hy slange 3/4'tank 1400 AB		
9	2	90515079	Hy slange AB 3/8'mellemsl 500mm		
10	1	90515084	Hy slange 5/8' pumpe 1400 AB		
11	1	90515082	Hy slange 5/8' retur 1600 AB		
A	1	90510130	Hy slangesæt f / AB komplet		
B	1	20200014	PVG 32 ventil klargjort AB		
C	1	20200013	Modulsystem 6 sekt klargjort t/AB		

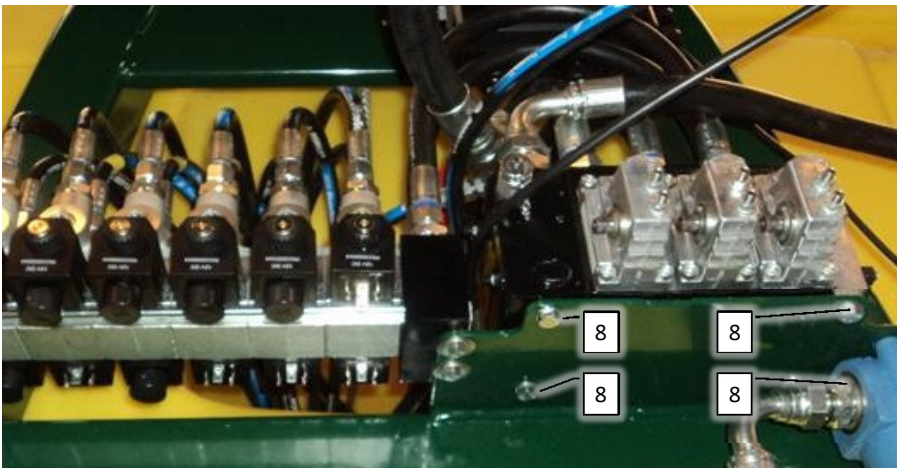
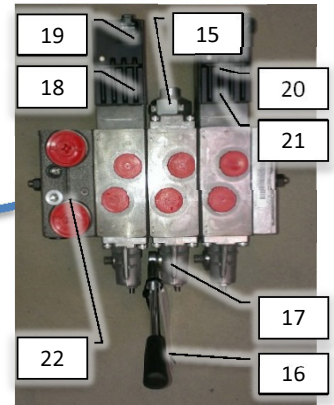
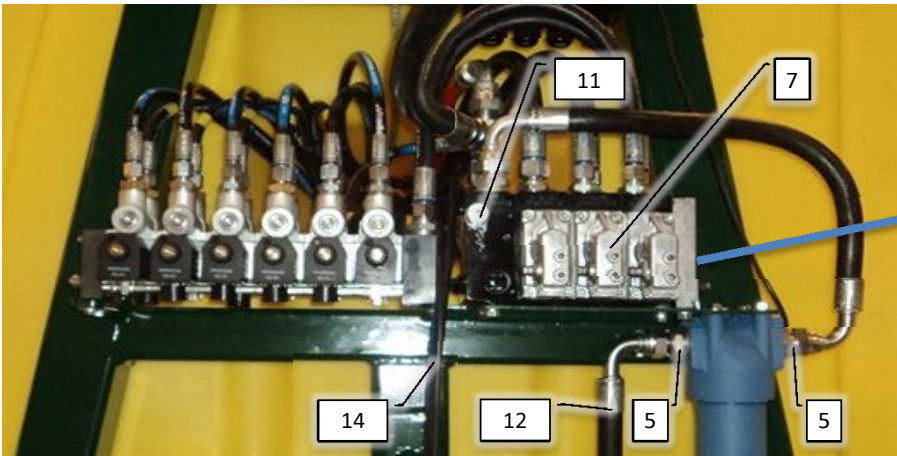
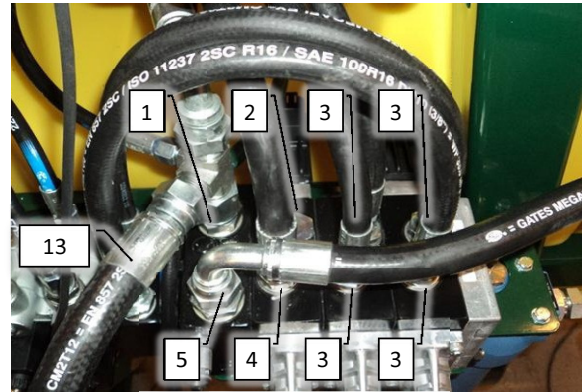
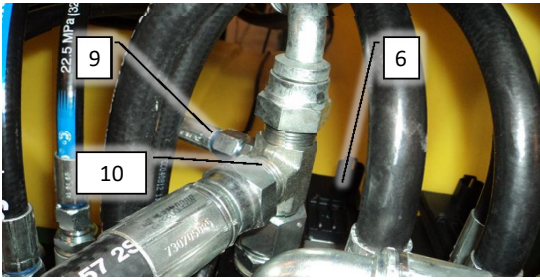



Pos	Psc	Number	Name	Price	Note
1	1	90510058	Bonded seal hydr. 3/4'		
	1	90510230	Hy brystnippel 3/4' x 3/4 BSP M/M		
2	1	90515204	Hy prop 1/2		
	1	90510057	Bonded seal hydr.1/2'		
3	1	90510043	Hy brystnippel 3/8'x1/2'		
	1	90510056	Bonded seal hydr. 3/8'		
4	1	90510035	Hy brystnippel 1/2' x 1/2'		
	1	90510057	Bonded seal hydr.1/2'		
5	1	90510045	Hy brystnippel 5/8' x 3/4'		
	1	90510058	Bonded seal hydr. 3/4'		
6	1	90510040	Hy brystnippel 1/4' x 1/4' BSP Male		
	1	90510055	Bonded seals hydr.1/4'		
7	1	90510049	PVG 32 Ventil 3 sektion		
	1	90510370	Hy pakningsæt PVG mont-sæt (PVAS32)		
	1	90510265	PVG stagbolte sæt 5 sek med pak		
8	1	90210011	Bolt M8x20 FZB 8.8 ubryst		
	1	90214406	Skive M8 FZB Facet		
9	1	90510079	Hy brystnippel 1/8' x 1/4'		
10	1	90510174	Hy Tee 3/4 MA/MA/FMA		
11	1	90510161	Hy Testnippel 1/4		
	1	90510055	Bonded seals hydr.1/4'		
12	2	90510058	Bonded seal hydr. 3/4'		
	1	90515084	Hy slange 5/8' pumpe 1400 AB		
	1	90320076	Hy brystnippel 1/2' x 5/8'		
	1	90510057	Bonded seal hydr.1/2'		
	1	90510032	Lynkobling 1/2' han		
13	1	90510058	Bonded seal hydr. 3/4'		
	1	90510230	Hy brystnippel 3/4' x 3/4 BSP M/M		
	1	90515085	Hy slange 3/4'tank 1400 AB		
	1	90510306	Hy lynkobling 3/4"		
14	1	90320015	Brystnippel 1/2' x 1/2'		
	1	90510301	Hy lynkobling 1/4"		
	1	90510057	Bonded seal hydr.1/2'		
15	1	90510052	PVMR32 m/friktionslås gl		
16	1	90321004	Håndtag t/danfoss PVG ventil		
17	1	90510053	PVM32 Mekanisk aktivering		
18	1	90510077	PVG 32 el-modul HI før 2010 (Hirsmann)		
19	1	90512004	PVG 32 El-modul PVEA efter 2010 (Deutz)		
20	1	90510210	PVG 32 el-modul on/off før 2010 Hirsmann		
21	1	90512012	PVG 32 el-modul on/off efter 2010 Deutz		
22	1	90510342	PVG indgangsmodul m/tryk-mængde forstærk		

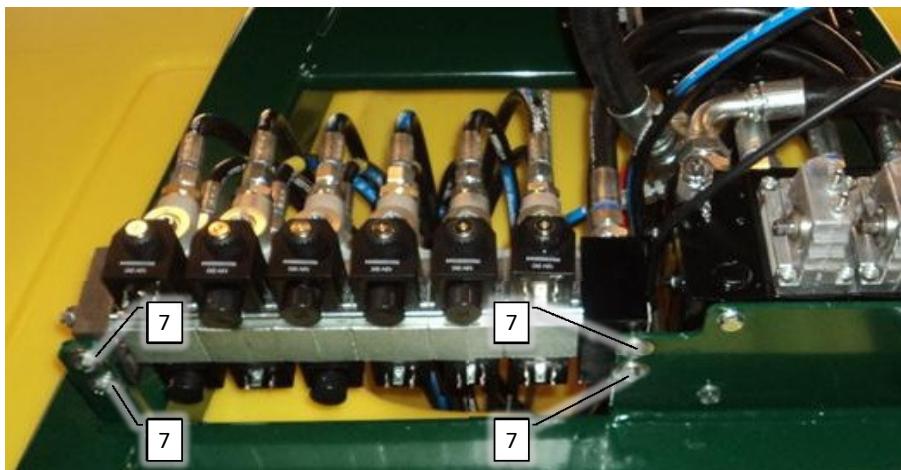
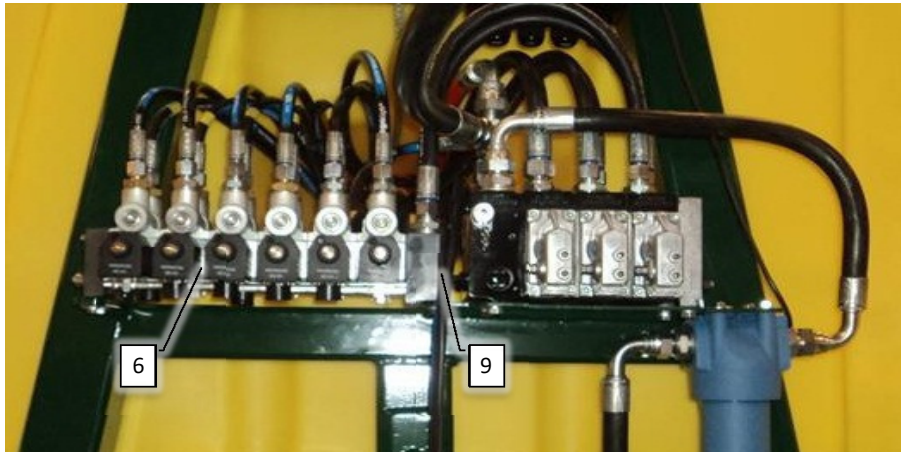
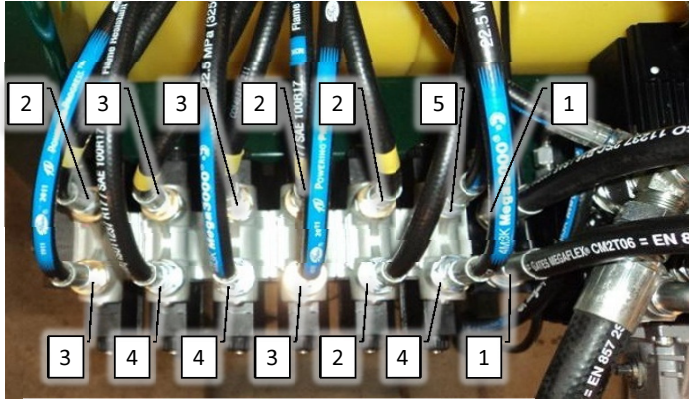

Pos	Psc	Number	Name	Price	Note
1	1	90510043	Hy brystnippel 3/8'x1/2'		
		90510057	Bonded seal hydr.1/2'		
2	1	90510060	Hy brystnippel 0,5 mm		
		90510057	Bonded seal hydr.1/2'		
3	1	90510061	Hy brystnippel 0,6 mm		
		90510057	Bonded seal hydr.1/2'		
4	1	90510041	Hy brystnippel 1/4' x 3/8'		
		90510056	Bonded seal hydr. 3/8'		
5	1	90510061	Hy brystnippel 0,6 mm		
		90510056	Bonded seal hydr. 3/8'		
6	1	90510260	Hy modulsystem 6 sek uden omløbsventil		
		90510124	Retningsventil f. hy. blok		
7	1	90210002	Bolt M6x20 FZB 8.8 ubryst		
		90214405	Skive M6 FZB Facet		
9	1	90510271	Hy prop 1/4		
		90510055	Bonded seals hydr.1/4'		



Pos	Psc	Number	Name	Price	Note
1	1	90320359	Låg for væskebeh 3000L CC		
2	1	90320360	Filter kurv f. væskeb. CC & AB		
3	1	90320365	Væskebeholder 1000 l Prova AB		
4	1	90320335	Slangest. 1"x25x90° Arag		
		1 90320518	Omløber 1" Arag		
		2 90325013	O-ring 1' Arag		
		1 90210186	Spændebånd 20-32/12- C7 W3		
	2,4	90340005	Slange 25 mm - tryk		
5	1	90320255	T-stykke 1' ARAG		
		2 90325061	Brystnippel 1" Arag		
6	1	90320434	Slangest. 1"x20x90° Arag		
		1 90320518	Omløber 1" Arag		
		2 90325013	O-ring 1' Arag		
		1 90210186	Spændebånd 20-32/12- C7 W3		
7	1	90329066	Autotanker/svømmer 1" ind. gevind		
8	1	90320278	Slangest. 3/4"x16x90°		
		1 90320429	Omløber 3/4 ARAG		
		2 90325024	O-ring 3/4" Arag NBR		
		1 90210088	Spændebånd 12-22/9 C7 W3		
9	1	90325101	Nippel (dbl) 3/4" Arag		
		1 90325068	Pakning 3/4" til Tankgennemf.		
		1 90320344	Møtrik f. tankgennemf. 3/4" Arag		
10	1	90320176	Tankmåler kit AB		
11	1	90320091	Vinkel 1'		
12	1	90320025	Tankgennemføring 1' dobb.		
		1 90320027	Pakning for 1' omløber, tankg.		
14	1	90320160	Tankgennemføring 2' Ak		
15	1	90325067	Pakning 2' for Bundventil		
16	1	90320026	Møtrik f. tankgennemf. 1" Arag		
17	1	90320481	Muffesæde 1 1/4 x 1"		
18	1	90320503	Slangest. 1 1/4"x32mm		
		1 90320513	Omløber 1 1/4' Arag		
		2 90325026	O-ring 1 1/4' Arag		
		1 90210089	Spændebånd 25-40/12 C7 W3		
	1,85	90340006	Slange 32 mm sug		
19	1	90329065	Bundventil EAB		
20	1	90320036	Lynkobling 1"-type F- han - udv. gev.		
21	1	90320400	Kontraventil rent vand 1'		
22	1	90320026	Møtrik f. tankgennemf. 1" Arag		
		1 90320025	Tankgennemføring 1' dobb.		
24	1	90320047	Lynkobling prop t/sug 1" m/arme		
25	1	90900070	Mærkat - tankskala AB		
27	1	20200090	Omrøring AB CC		
28	1	90320087	Spidsmuffe 1' x 1/2'		
		1 90320241	T-stykke 1/2'		
		2 90320260	Slangeforsk. 1/2"x13mm		
		2 90210088	Spændebånd 12-22/9 C7 W3		
29	0,5	90340003	Slange 13,0 mm - tryk		
		1 90210088	Spændebånd 12-22/9 C7 W3		
		1 90320128	Tankspuler polm		
30	2,8	90340006	Slange 32 mm sug		
A	1	20200071	Fitting der følger med Kemikaliefyl		

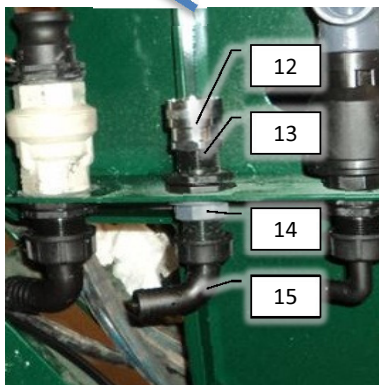
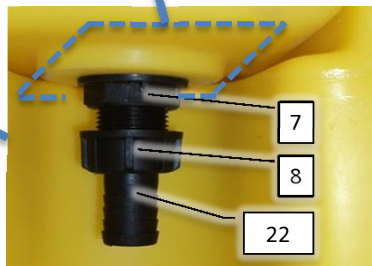
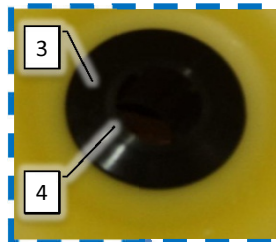
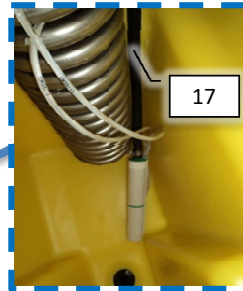
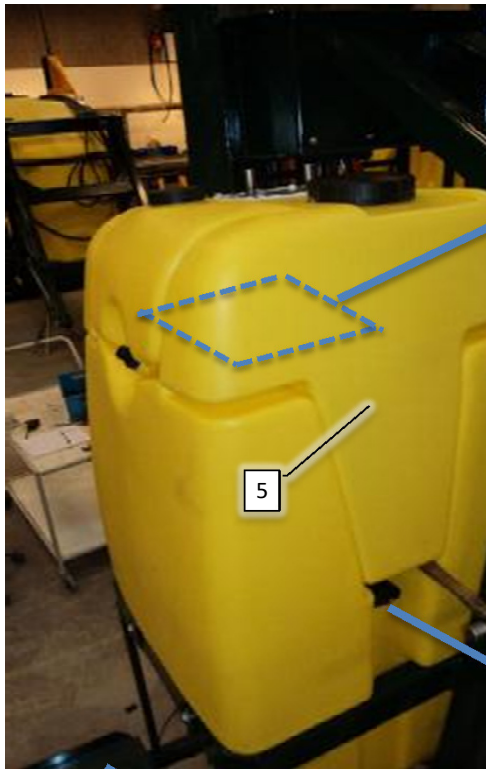
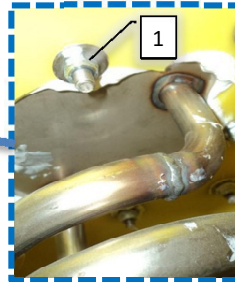
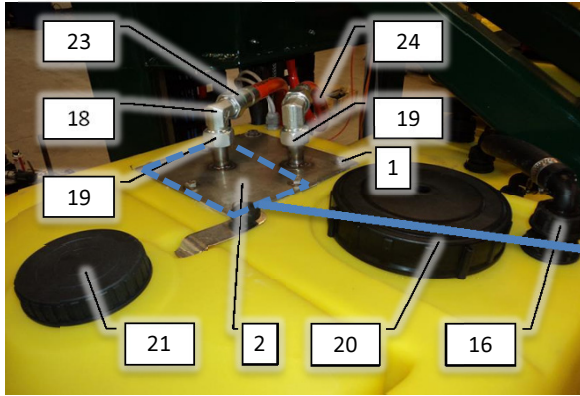

Pos	Psc	Number	Name	Price	Note
1	1	90214420	Bolt M8x25 A2		
	1	90510050	Hy kobberring 1/4"		
	1	90214414	Skive M8 8,4x24x2 A2 Skærm		
	1	90214502	Møtrik M8 A2 Låse		
	1	90510516	Kobberring Ø8x14x1		
2	1	90330097	Oliekølerspiral f vandtank EAB		
3	1	90320088	Tankgennemføring 1'		
4	1	90320027	Pakning for 1' omløber, tankg.		
5	1	90320366	Rentvandstank 100l EAB		
7	1	90320026	Møtrik f. tankgennemf. 1" Arag		
8	1	90320518	Omløber 1" Arag		
	1	90325012	Slangest. 1"x25mm Arag		
	1	90325013	O-ring 1' Arag		
	1	90210186	Spændebånd 20-32/12- C7 W3		
12	1	90320037	Lynkobl hun Nito retursk 3/4'		
13	1	90325101	Nippel (dbl) 3/4" Arag		
14	1	90320344	Møtrik f. tankgennemf. 3/4" Arag		
15	1	90320433	Slangest. 3/4"x20x90° Arag		
	1	90320429	Omløber 3/4 ARAG		
	2	90325024	O-ring 3/4" Arag NBR		
	1	90210088	Spændebånd 12-22/9 C7 W3		
16	1	90320088	Tankgennemføring 1'		
	1	90320027	Pakning for 1' omløber, tankg.		
	1	90320026	Møtrik f. tankgennemf. 1" Arag		
	1	90320518	Omløber 1" Arag		
	1	90320434	Slangest. 1"x20x90° Arag		
	1	90325012	Slangest. 1"x25mm Arag		
	2	90325013	O-ring 1' Arag		
	1	90210186	Spændebånd 20-32/12- C7 W3		
17	1	90320060	Dykpumpe		
	2	90340003	Slange 13,0 mm - tryk		
18	1	90320179	PG 11 lang model		
	1	90320712	Møtrik f. PG 11 ledn.gennef. grå		
19	1	90517600	Hy Vinkelsamler ø18L udv x ø18L udv		
	1	90517601	Dobbelt skærring ø18L		
	1	90517602	Hy Omløber ø18L M26x1.5		
20	1	90320362	Låg stor for renvandtank CC&AB		
21	1	90320361	Låg lille for renvandtank CC&AB		
22	2	90340044	Slange 25 mm sug		
23	1	90515081	Hy slange 1/2'blæser 4200 AB		
24	1	90515082	Hy slange 5/8' retur 1600 AB		

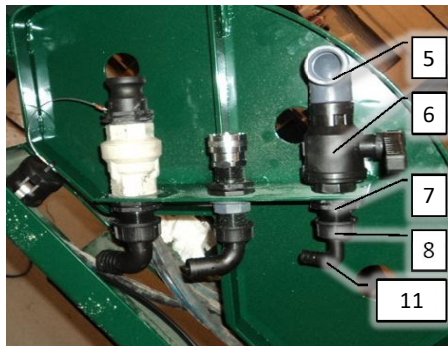
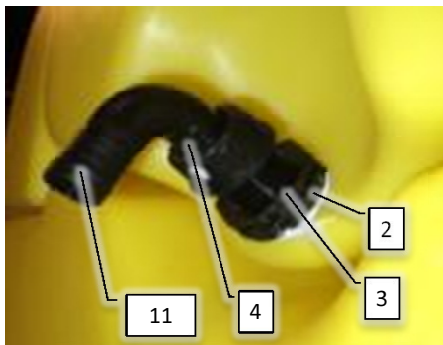
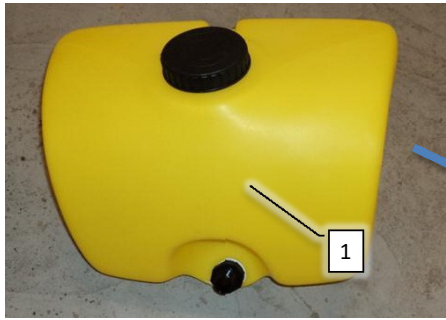



Pos	Psc	Number	Name	Price	Note
1	1	90320367	Håndvasktank 16 l EAB		
2	1	90325068	Pakning 3/4" til Tankgennemf.		
3	1	90320322	Brystnippel 3/4" x 3/4" Arag		
4	1	90320386	Slangest. 3/4" x 13 x 90° Arag		
		1 90320429	Omløber 3/4 ARAG		
		2 90325024	O-ring 3/4" Arag NBR		
		1 90210098	Spændebånd 16-27/12 C7 W3		
5	1	90320032	Spidsmuffe vinkel 3/4x3/4x90		
6	1	90320042	Kuglehane til rent vand 3/4"		
7	1	90325101	Nippel (dbl) 3/4" Arag		
		1 90320344	Møtrik f. tankgennemf. 3/4" Arag		
8	1	90320386	Slangest. 3/4" x 13 x 90° Arag		
		1 90320429	Omløber 3/4 ARAG		
		2 90325024	O-ring 3/4" Arag NBR		
		1 90210088	Spændebånd 12-22/9 C7 W3		
9	1	90320708	Rørholder 20 mm enkelt		
		2 90210004	Bolt M6x30 FZB 8.8 ubrust		
10	1	90320361	Låg lille for renavdntank CC&AB		
11	3,3	90340003	Slange 13,0 mm - tryk		

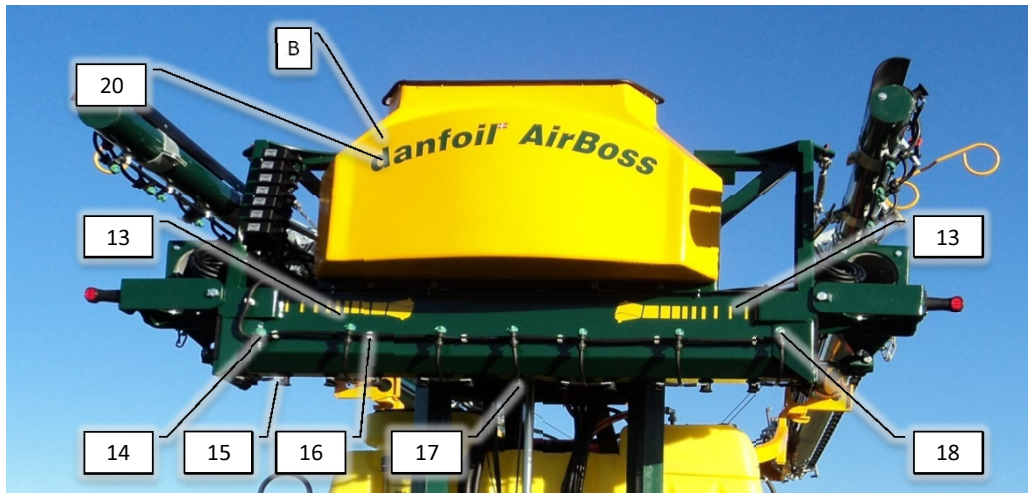
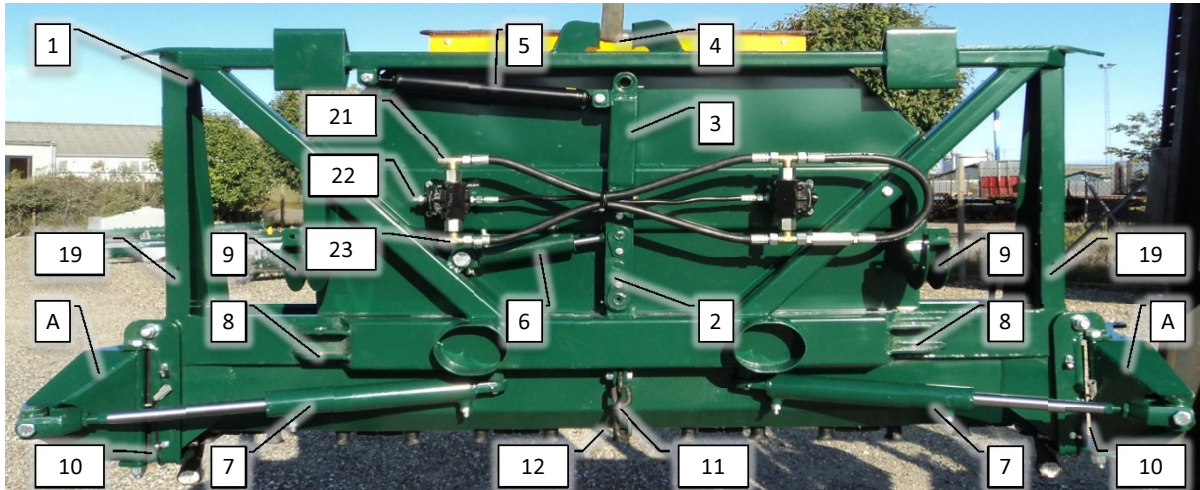

Pos	Psc	Number	Name	Price	Note
1	1	90330434	Luftfordeler AB		
2	1	90330478	Justerled til AB luftfordeler		
	1	90330479	Bolt for justerled AB $\varnothing 20 \times 44$		
	2	90330480	Bolt for justerled AB $\varnothing 25 \times 48$		
	3	90214406	Skive M8 FZB Facet		
	1	90210011	Bolt M8x20 FZB 8.8 ubrust		
	2	90210129	Smørenippel lige 6 mm		
3	1	90330436	Løfteled for AB		
	1	90210042	Bolt M12x70 FZB 8.8 ubrust		
	1	90214408	Skive M12 FZB Facet		
	1	90210056	Møtrik M12 FZB låse		
	2	90210129	Smørenippel lige 6 mm		
4	1	90210283	Expanderbolt kpl. $\varnothing 25 \times 124$		
	2	90330558	Bøsning $\varnothing 33,7 \times 2 \times 24$ mm AISI 304 rør		
5	1	90214402	Gasstøddæmper vandret CC-AB		
	2	90210042	Bolt M12x70 FZB 8.8 ubrust		
	2	90210056	Møtrik M12 FZB låse		
	4	90214408	Skive M12 FZB Facet		
6	1	90510063	Cylinder tilt AB		
	1	90510176	Hy pakningssæt t. cyl. 4020		
	1	90510041	Hy brystnippel 1/4' x 3/8'		
	1	90510056	Bonded seal hydr. 3/8'		
	1	90210022	Bolt M20x70 FZB 8.8 ubrust		
	1	90210077	Skive M20 FZB Facet		
	1	90210069	Møtrik M20 FZB låse		
7	1	90510062	Cylinder inderbom AB		
	1	90510026	Hy pakn.Sæt 50-30 Inderb Ab		
	1	90210034	Bolt M10x30 FZB 8.8 ubrust		
	1	90210078	Skive M10.5x30x2.5 Plan A2		
	4	90515076	Hy slange AB CCII 1/4'bom 4700mm		
	2	90515170	Hy slange 1/4" bomslange t/rustfri 800mm		
	1	90510041	Hy brystnippel 1/4' x 3/8'		
8	1	90210282	Expanderbolt kpl. $\varnothing 25 \times 114$		
	2	90330559	Bøsning $\varnothing 33,7 \times 2 \times 14$ mm AISI 304 rør		
9	1	90210199	Øje/ringbolt 10mm el-galv		
	1	90210055	Møtrik M10 FZB låse		
10	1	90407601	Induktiv Sensor M12 6mm AB Bomlås		
	1	90403702	Hjulføler ledning 10m induktiv		
11	1	90210313	Kæde 4 led 13mm		
	1	90210116	Sjækkel 16mm (1/2') Crosby		
	1	90210039	Bolt M12x50 FZB 8.8 ubrust		
	1	90210056	Møtrik M12 FZB låse		
	1	90214408	Skive M12 FZB Facet		
12	1	90320190	Slangeholder 12mm dobbelt grøn		
13	1	90900041	Mærkat - eurofoil (gul) AB/CC		
14	1	90326060	Drypstop dobb. kpl. 2011		
15	12	90320083	Eurofoil forstøver kompl.		
	6	90326014	Fordeler db t/ forstøv sort/grå Tysk/ny		
16	7	90326020	Slangeholder 16 mm enkelt WOPF		
17	1	90320083	Eurofoil forstøver kompl.		
	1	90326028	Fordeler t/sorst. enk. sort lige 2013		
18	1	90326055	Drypstop Højre enkelt 2011		
19	1	90320704	Rørholder 15x15 m/top kpl.		
20	1	90900057	Mærkat - Danfoil ( bagend AB)		
21	1	90515081	Hy slange 1/2'blæser 4200 AB		
22	1	90515072	Hy slange 1/4'dræn 4100 AB		
		90510041	Hy brystnippel 1/4' x 3/8'		
23	1	90515080	Hy slange 1/2'blæser 3250 AB		
A	1	20200180	Mellemleds sæt		
B	1	20200190	Blæsekasse komp.		

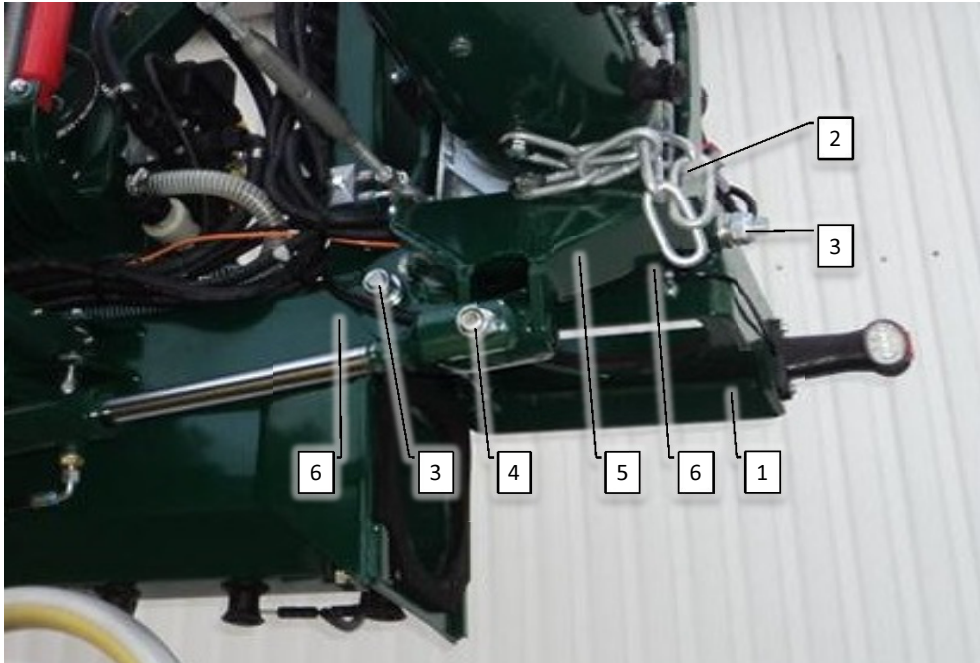

Pos	Psc	Number	Name	Price	Note
1	4	90804245	Svampegummi Ø 200 x13 mm		
	1	90330425	Mellemlid H for AB		
	1	90330426	Mellemlid V for AB		
	2	90407526	Slingrelygte klp. AirBoss		
	4	90210128	Bolt M6x16 FZB 8.8 ubrust		
	4	90214405	Skive M6 FZB Facet		
	4	90215031	Clamps 7mm 7/16		
2	2	90210314	Kæde 8 led 10mm		
	1	90210017	Bolt M12x30 FZB 8.8 ubrust		
	1	90210082	Skive M6 FZB Stjerne		
	1	90210056	Møtrik M12 FZB låse		
	1	90210017	Bolt M12x30 FZB 8.8 ubrust		
	1	90210082	Skive M6 FZB Stjerne		
	1	90210056	Møtrik M12 FZB låse		
3	2	90210189	Bolt M20x370 FZB 8.8 AB/CC inderled		
	2	90210069	Møtrik M20 FZB låse		
	2	90210077	Skive M20 FZB Facet		
4	2	90210045	Bolt M20x120 FZB 8.8 brust		
	2	90210069	Møtrik M20 FZB låse		
	2	90210077	Skive M20 FZB Facet		
5	2	90330427	Inderled for AB		
6	2	90215036	Clamps 8mm 8/15		

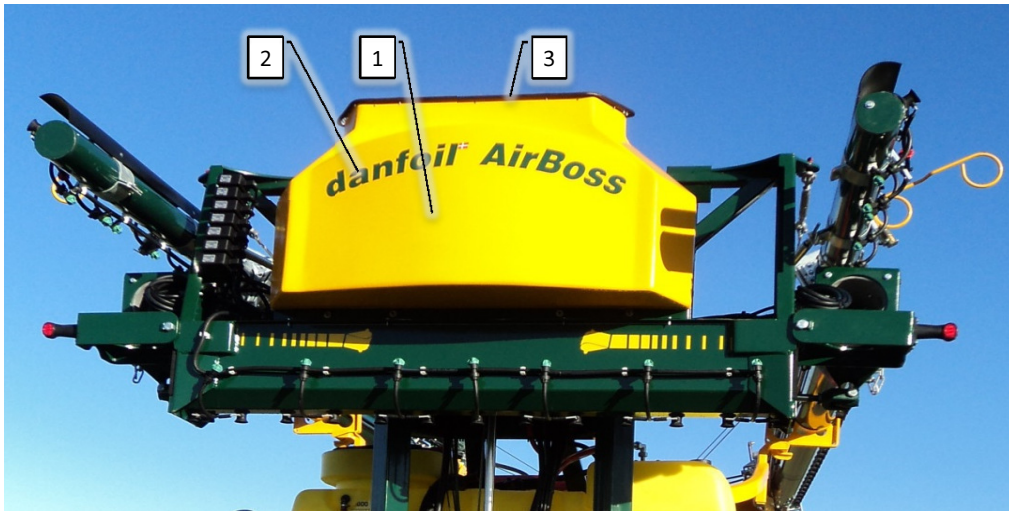
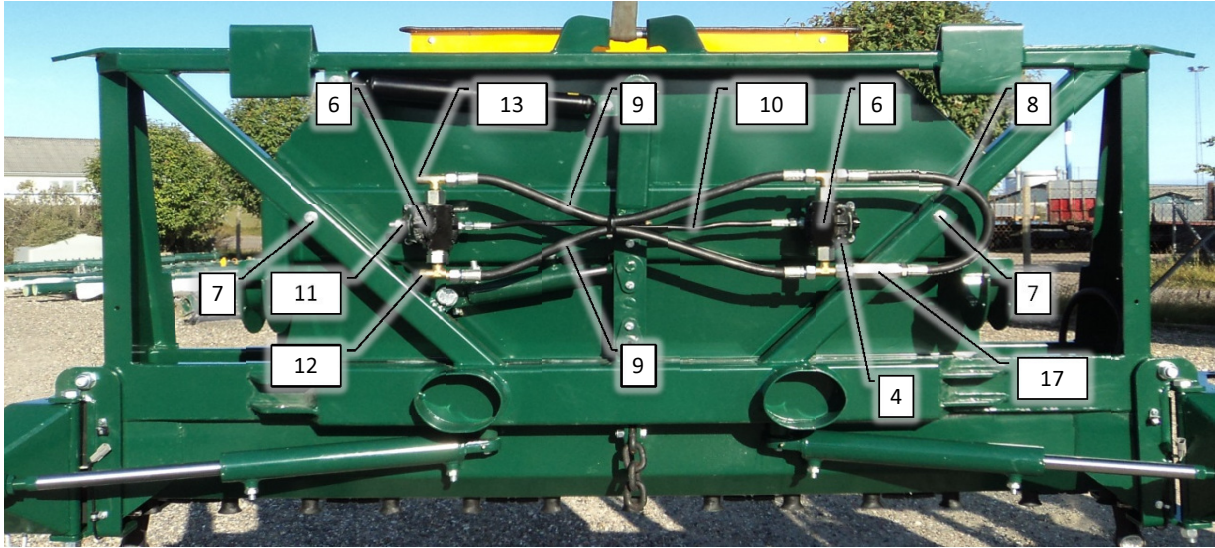

Pos	Psc	Number	Name	Price	Note
1	1	90330390	Blæsehus CC-AB		
		90330356	Indsugningstragt CC/AB Spila		
	8	90210310	Selvkærende skrue 4,8x 32mm Torx		
	2	90330460	Luftfordeleplade t. Spila AB/CC		
3	1	90330424	Indsugningsrist AB/CC		
	8	90210310	Selvkærende skrue 4,8x 32mm Torx		
	8	90210083	Skive M6,4x18x1,6 Plan		
	2	90330067	Kantliste til luftkasse CC & AB		
4	2	90510048	Spændelement 20 x 47 mm		
	16	90210084	Skive M8 8,4x24x2 Plan		
	16	90210054	Møtrik M8 FZB låse		
	1	90330146	Blæsehjul CC/AB Højre		
	1	90330189	Blæsehjul CC/AB Venstre		
6	1	90510105	Hy stempelmotor blæser 12 CCM		
	1	90510014	Hy paksæt f. stempelmo. F.H1C/		
	4	90210054	Møtrik M8 FZB låse		
	2	90510166	Hy T1/2BSP t.Stk Ma/T.Ma/Ma		
	2	90510237	Hy nippelmuffe 1/2 BSP indv x 3/4 BSP udv		
7	3	90210081	Skive M12 13x37x3 Plan		
	1	90214408	Skive M12 FZB Facet		
	1	90210043	Bolt M12x80 FZB 8.8 ubrust		
8	1	90515087	Hy slange AB CCII 1/2' motor 550mm		
9	1	90515086	Hy slange AB CCII 1/2' motor 650mm		
10	1	90515073	Hy slange AB CCII 1/4' dræn 600mm		
	2	90510041	Hy brystnippel 1/4' x 3/8'		
17	1	90510165	Hy kontraventil 1/2"		
	1	90510345	Hy nippel m/omløber 1/2 BSP		

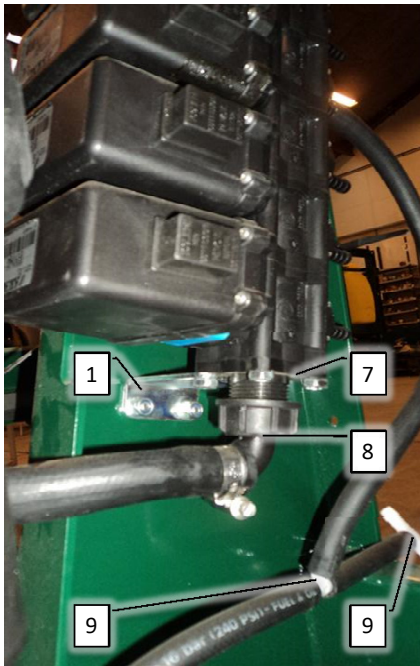
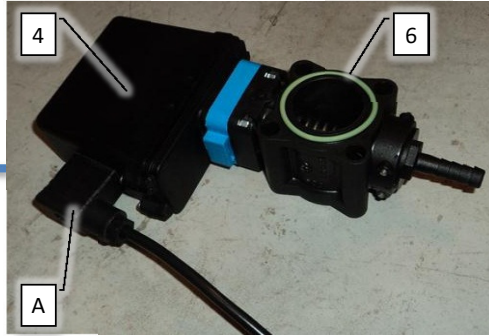
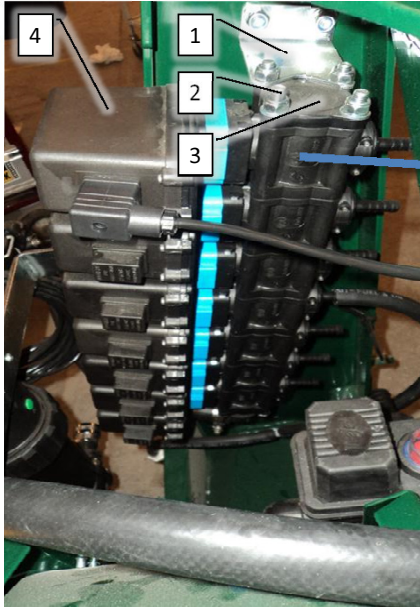



Pos	Psc	Number	Name	Price	Note
1	1	90320459	Beslag for væskeventil (Arag)		
	2	90210012	Bolt M8x25 FZB 8.8 ubryst		
	4	90214406	Skive M8 FZB Facet		
	2	90210054	Møtrik M8 FZB låse		
2	1	90320395	Stavbolte ARAG (7)		
	1	90214406	Skive M8 FZB Facet		
	1	90210054	Møtrik M8 FZB låse		
3	1	90320396	Endedæksel ARAG hun		
4	1	90400166	Motorventil ARAG sektion væs 10mm		
6	1	90320145	O-ring Arag sek. ventil 39,2x2,6 Viton		
7	1	90320399	Endedæksel 1' han ARAG		
8	1	90320434	Slangest. 1"x20x90° Arag		
	1	90320518	Omløber 1" Arag		
	2	90325013	O-ring 1' Arag		
	1	90210098	Spændebånd 16-27/12 C7 W3		
9	1	90320243	T-slangestuds 10-10-10mm/TS 10		
A	1	90400184	Kabel f. væskeventiler 7 sek. AB		

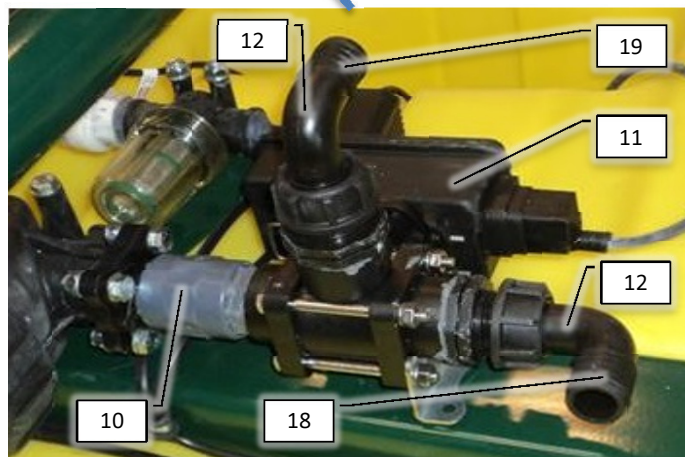
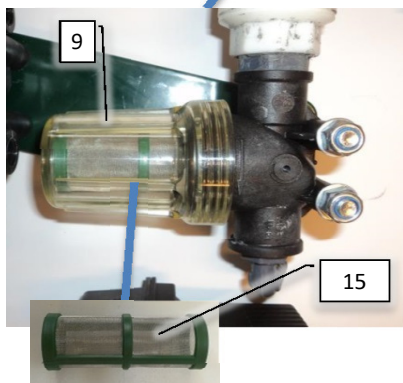
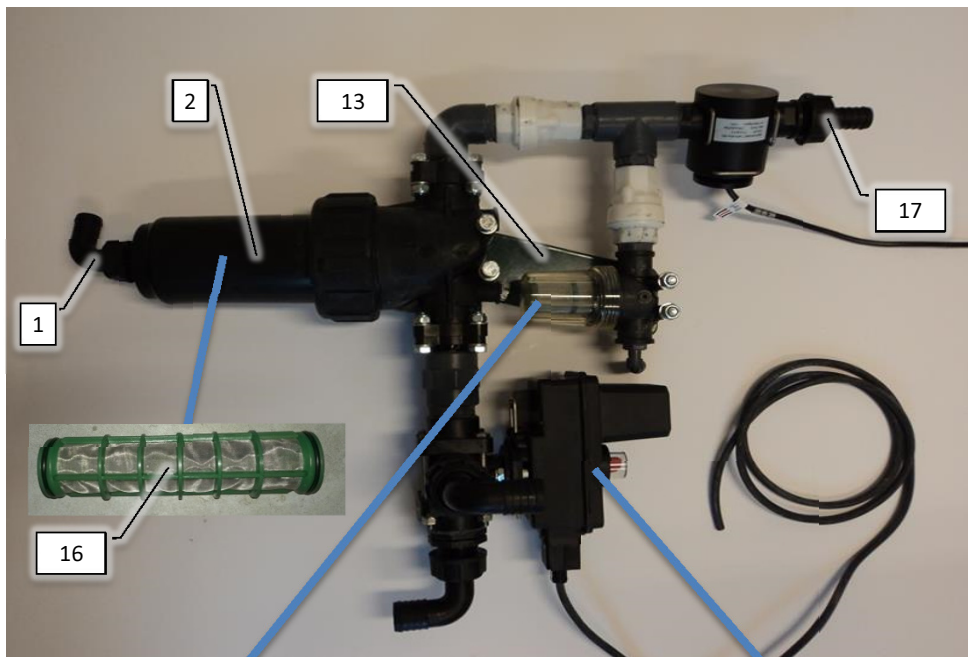
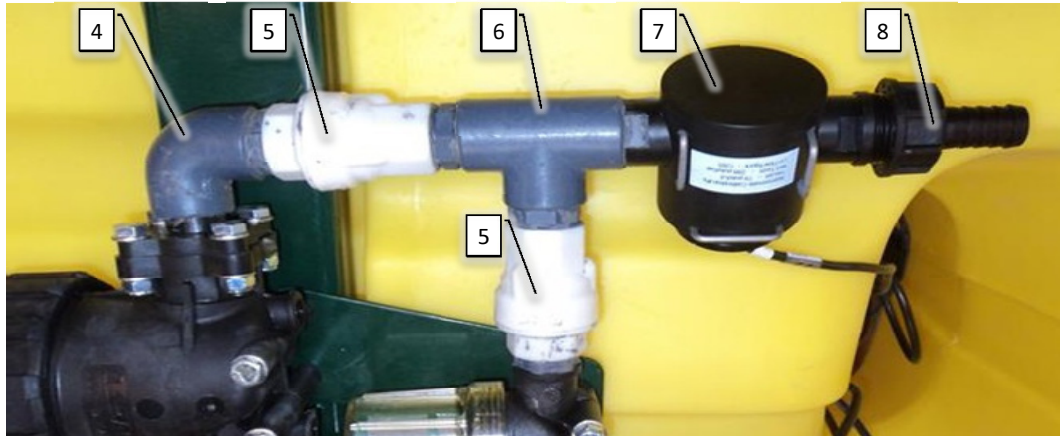

Pos	Psc	Number	Name	Price	Note
1	1	90320433	Slangest. 3/4"x20x90° Arag		
	2	90325024	O-ring 3/4" Arag NBR		
	1	90320429	Omløber 3/4 ARAG		
	1	90210088	Spændebånd 12-22/9 C7 W3		
2	1	90320410	Filterhus kpl m. flanger ARAG		
	1	90320415	O-ring for filterhus 1995		
4	1	90320398	Endedæksel 3/4' hun ARAG		
	4	90210030	Bolt M8x30 FZB 8.8		
	1	90320229	Vinkel 3/4' 90°		
	1	90320017	Brystnippel 3/4' x 3/4' grå		
5	1	90320034	Kontraventil rent vand 3/4'		
6	1	90320021	T-stykke 3/4 x 3/4 x 3/4 Grå		
	2	90320017	Brystnippel 3/4' x 3/4' grå		
7	1	90400018	Flowmåler Ø16mm x 10m ledning		
	1	90400019	Gevindstuds Ø16 udv.gevind 3/4"		
	1	90400196	1" gevindstuds f. flowmåler		
8	1	90320432	Slangest. 1"x 20mm Arag		
	1	90320518	Omløber 1" Arag		
	2	90325013	O-ring 1' Arag		
	1	90210186	Spændebånd 20-32/12- C7 W3		
9	1	90320418	Liniefilter ARAG 1/2'		
	1	90320016	Brystnippel 3/4' x 1/2'		
	1	90320291	Slangeforsk. 1/2"x12x90°		
	2	90210001	Bolt M6x80 FZB 8.8 bryst		
10	1	90320399	Endedæksel 1' han ARAG		
	4	90210030	Bolt M8x30 FZB 8.8		
	1	90320028	Muffe 1'		
	1	90320019	Brystnippel 1' x 1'		
11	1	90400027	Motorventil 1' k.afh EAB-ECC		
	1	90400162	Kabel f. motorventil l,5m		
	1	90320411	Beslag for motorventil		
	2	90210001	Bolt M6x80 FZB 8.8 bryst		
12	1	90320335	Slangest. 1"x25x90° Arag		
	1	90320518	Omløber 1" Arag		
	2	90325013	O-ring 1' Arag		
	1	90325061	Brystnippel 1" Arag		
	1	90210186	Spændebånd 20-32/12- C7 W3		
13	1	90330208	Amaturplade f. væske		
14	1	90320043	Bundskål t. filterhus		
15	1	90320419	Filterindsa f/ARAG liniefilter		
16	1	90320113	Filterinds.grøn model ARAG tryk		
17	3,5	90340004	Slange 19 mm - tryk		
18	2,5	90340005	Slange 25 mm - tryk		
19	0,75	90340005	Slange 25 mm - tryk		

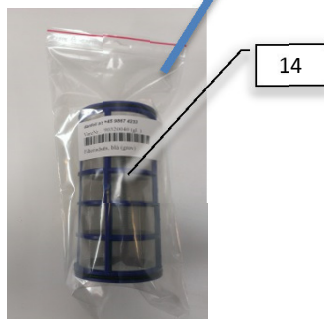
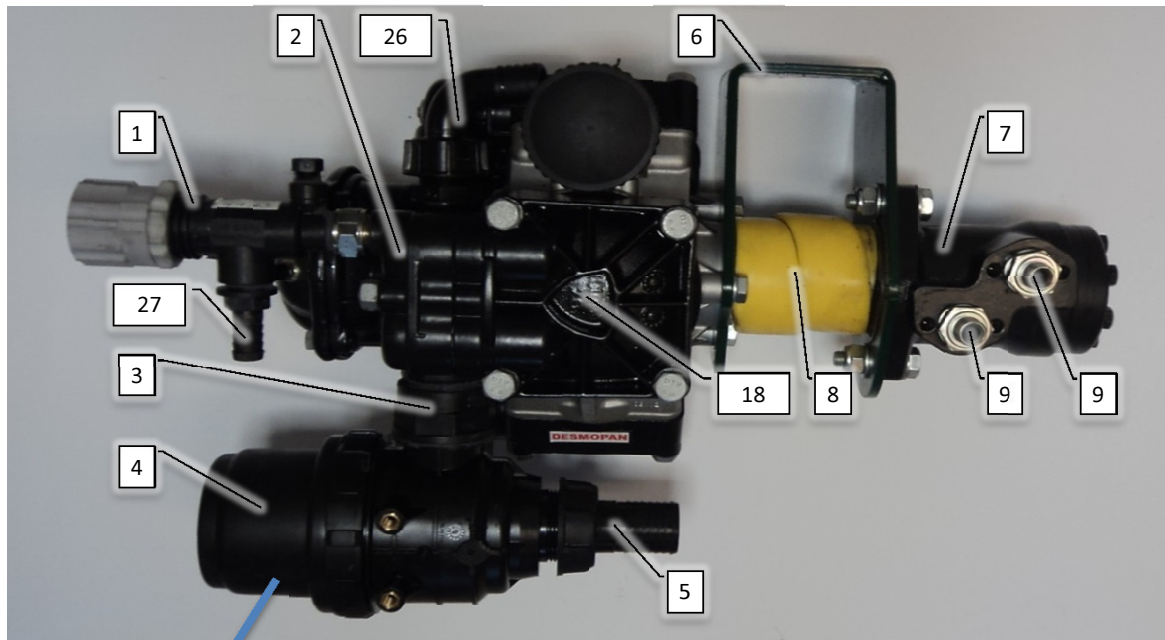
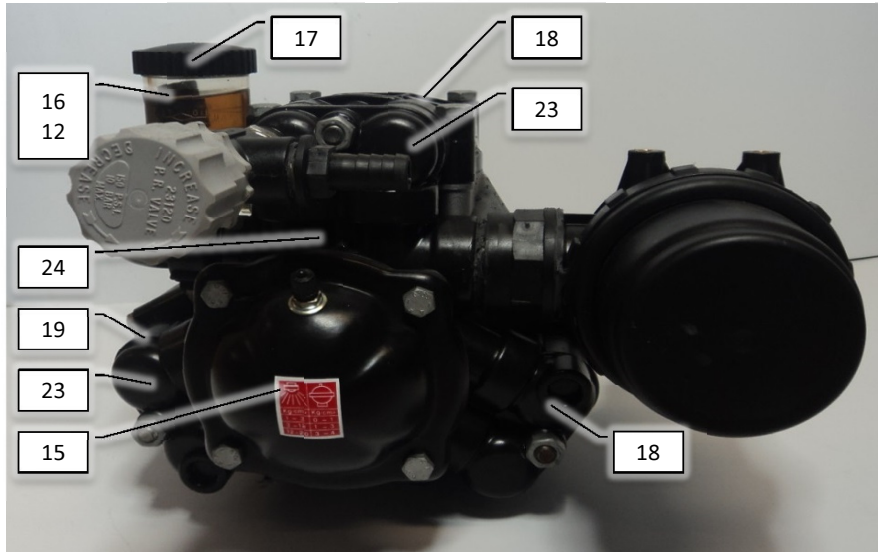

Pos	Psc	Number	Name	Price	Note
1	1	90320125	Overtryksventil (vædske) 1/2'		
	1	90320259	Slangeforsk. 1/2"x16mm sort		
	1	90210088	Spændebånd 12-22/9 C7 W3		
2	1	90320049	Væskepumpe 3 cyl. AR 115 bp		
3	1	90320264	Spidsmuffe 1 1/2' x 1 1/4'		
4	1	90320045A	Sugefilter kpl. 1 1/2'/blå!50m		
	1	90320039	O-ring, Ø 5,70,Sugefilter		
5	1	90320491	Slangest. 1 1/2"x35 Arag		
	1	90325063	Omløber 1 1/2"		
	2	90325016	O-ring 1 1/2" Arag		
	1	90210088	Spændebånd 12-22/9 C7 W3		
	1,85	90340006	Slange 32 mm sug		
6	1	90330445	Pumpebeslag svejst for AB		
	0,1	90100013	Slangebeskyttelse Ø75mm gul		
	3	90340000	Slange 16 mm tryk		
7	1	90510047	Oliemotor OMP 25 AB		
8	1	90330164	Adapter f/pumpestation AB		
	8	90210056	Møtrik M12 FZB låse		
	2	90210017	Bolt M12x30 FZB 8.8 ubryst		
	3	90210027	Bolt M10x25 FZB 8.8 ubryst		
	2	90210088	Spændebånd 12-22/9 C7 W3		
9	1	90510043	Hy brystnippel 3/8'x1/2'		
	1	90510057	Bonded seal hydr.1/2'		
	1	90515078	Hy slange 3/8' væskep 2100 AB		
10	1	90320050	Ventil for AR 115		
	1	90320049D	Ventil til pumpe AR 100-115-160-185BP		
11	1	90320050 A	O-ring for ventil AR 100, 115,160, 185BP		
12	1	90320202	Olierglas t. AR 115		
16	1	90320450	Olierglas stor		
17	1	90320050C	Låg for olierglas f AR 115		
13	1	90320092	Membran AR 115 bp, pr. stk.		
	3	90320092-3	Membran AR 115 bp. 3stk		
14	1	90320040	Filterindsats, blå (grov)		
15	1	90320048D	Vindkedel m/hus komplet t/115		
	1	90320048B	Membran f/vindkedel AR 100/115		
18	1	90320525	Topstykke AR 115 RHS		
19	1	90320526	Topstykke AR 115 LHS		
21	1	90320217	O-ring sæt for AR 115		
22	1	90320048	Rep.sæt til pumpe AR 115 bp		
23	1	90320168	Ventilhus til ar 115 R		
24	1	90320169	Ventilhusfod til Ar 115		
25	1	90320049B	Stempel til AR115		
26	3,1	90340005	Slange 25 mm - tryk		
	1	90320335	Slangest. 1"x25x90° Arag		
	1	90320518	Omløber 1" Arag		
	2	90325013	O-ring 1' Arag		
	1	90210186	Spændebånd 20-32/12- C7 W3		
27	3,4	90340000	Slange 16 mm tryk		

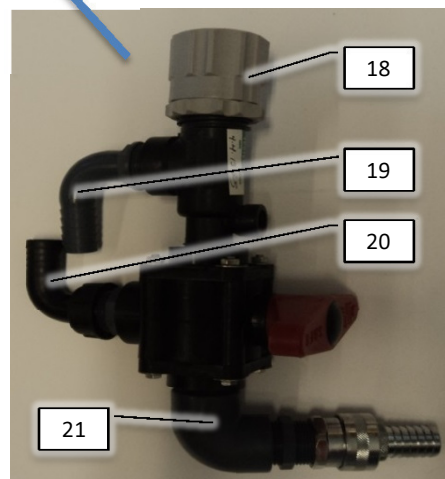
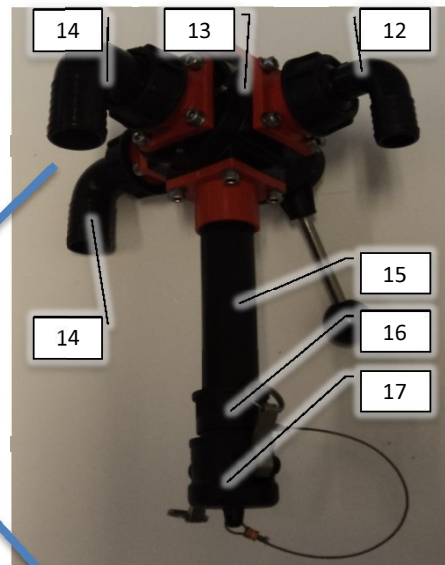
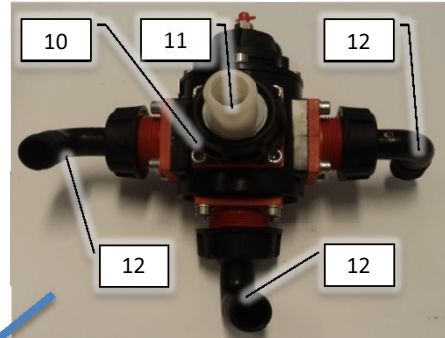
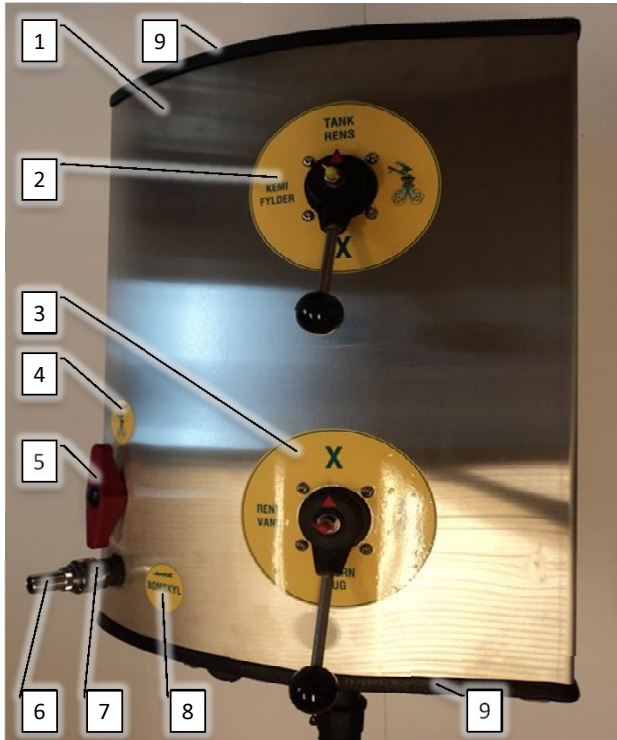

Pos	Psc	Number	Name	Price	Note
1	1	90330452	Filterplade t. AB		
2	1	90900048	Mærkat- filter/kemifylder CC-AB DK		
3	1	90900062	Mærkat - filter/rengøring AB		
4	1	90900065	Mærkat - filter/foil AB/CC		
5	1	90320057	SAFI-hane 3/4' - 3 vejs		
	3	90320017	Brystnippel 3/4' x 3/4' grå		
6	1	90320038	Lynkobling han returskyl 3/4'		
7	1	90320037	Lynkobl hun Nito retursk 3/4'		
8	1	90900068	Mærkat - filter/bomskyl AB/CC		
9	2	90330067	Kantliste til luftkasse CC & AB		
10	1	90320209	Ventil Polmac 4-vejs lille AB tryk		
11	1	90320501	Slangest.1 1/4"x25mm		
	1	90320513	Omløber 1 1/4' Arag		
	2	90325026	O-ring 1 1/4' Arag		
12	1	90320504	Slangest. 1 1/4"x25x90°		
	1	90320513	Omløber 1 1/4' Arag		
	2	90325026	O-ring 1 1/4' Arag		
13	1	90320166	Ventil Polmac 4-vejs lille AB sug/CC try		
14	1	90320531	Slangest.1 1/4x32x90° O.ring		
	1	90320513	Omløber 1 1/4' Arag		
	2	90325026	O-ring 1 1/4' Arag		
15	1	90320187	Nippelrør 1' x 150 mm		
16	1	90329514	Kobling 1" han m/indvendigt gev.		
17	1	90320047	Lynkobling prop t/sug 1" m/arme		
18	1	90320124	Overtryksventil (væske) 3/4'		
19	1	90320005	Slangeforsk.3/4"x20mmx90°		
	2,2	90340004	Slange 19 mm - tryk		
20	1	90320433	Slangest. 3/4"x20x90° Arag		
	1	90320429	Omløber 3/4 ARAG		
	2	90325024	O-ring 3/4" Arag NBR		
	1	90210088	Spændebånd 12-22/9 C7 W3		
	3	90340004	Slange 19 mm - tryk		
21	1	90320229	Vinkel 3/4' 90°		
22	1	90900161	Mærkat "henstilling af sprøjte"		
23	1	90900163	Mærkat "udtrækning af støtteben"		
24	1	90900083	Mærkat-advarsel-læs instruktionsbog		

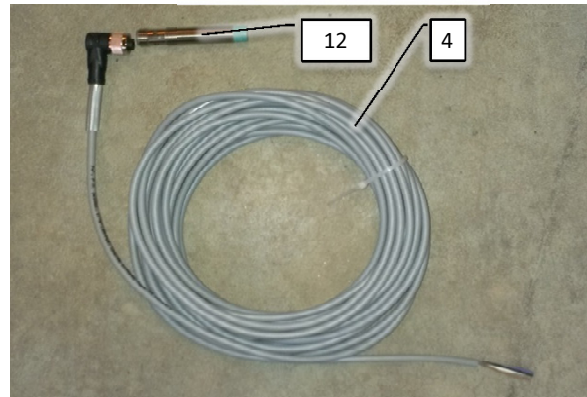
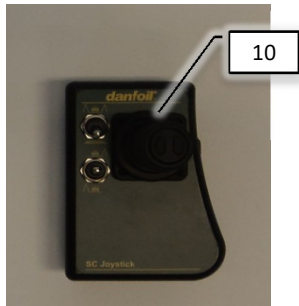
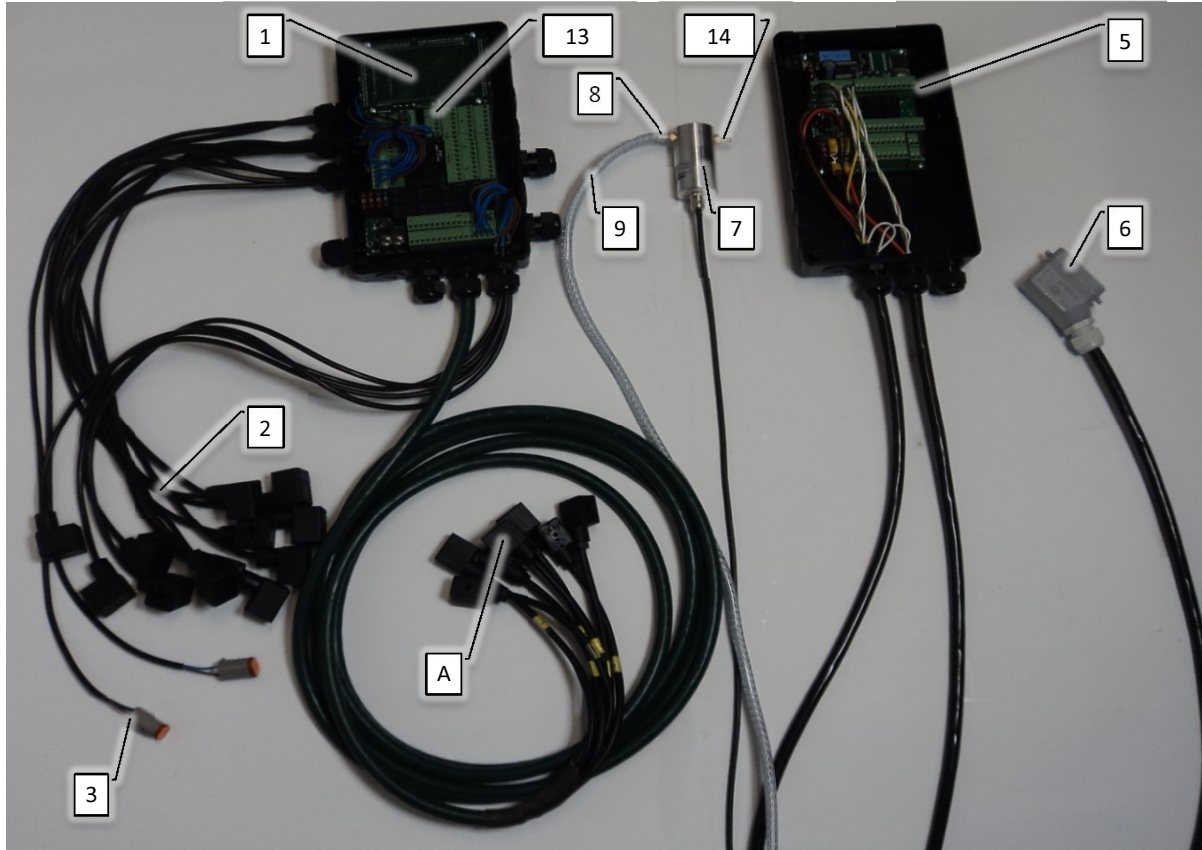



Pos	Psc	Number	Name	Price	Note
1	1	90404601	Jobcomputer f/Spray Controller V1		
13	1	90404640	Print t/jobcomputer (løs) Lykketronic		
2	12	90400169	Stik f. hyd. ventil incl. ledning 1000mm		
3	2	90400172	Stik f. PVG ventil incl. ledning		
4	2	90403702	Hjulføler ledning 10m induktiv		
12	2	90403701	Hjulføler induktiv		
5	1	90404602	Mini jobcomputer f/Spray Controller V1		
6	1	90409852	Kontakt hus 6 pol han maskindel		
		1 90409853	Indsats t/6 polet stik han		
		1 90400068	Gennemføring pg 16 Grå		
	2,1	90400040	Kabel 6x1 + 1x2.5 sort kappe		
7	1	90404605	Tryktransmitter t/luftstyring		
8	3	90807360	Slangenippel t/tryktransducer 1/8" x 5		
9	6	90340010	Klar slange luft 5 mm		
10	1	90404603	Joystick f/Spray Contr. V1-Airboss		
11	1	90404650	Montageskinne Lykketronic enhed		
14	0,5	90340010	Klar slange luft 5 mm		
A	1	90400184	Kabel f. væskeventiler 7 sek. AB		
B	1	20200050	Dele f. montering på traktor std. AB-CC		

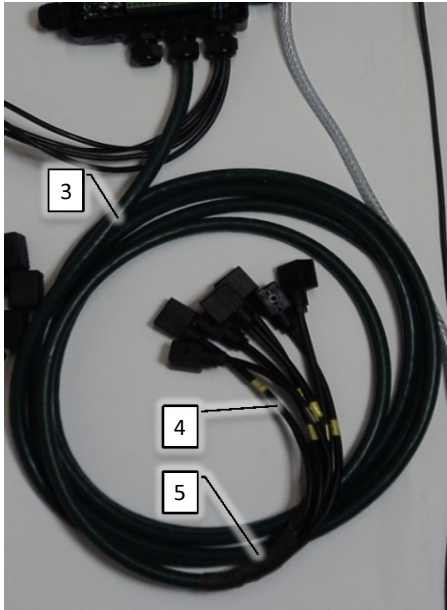
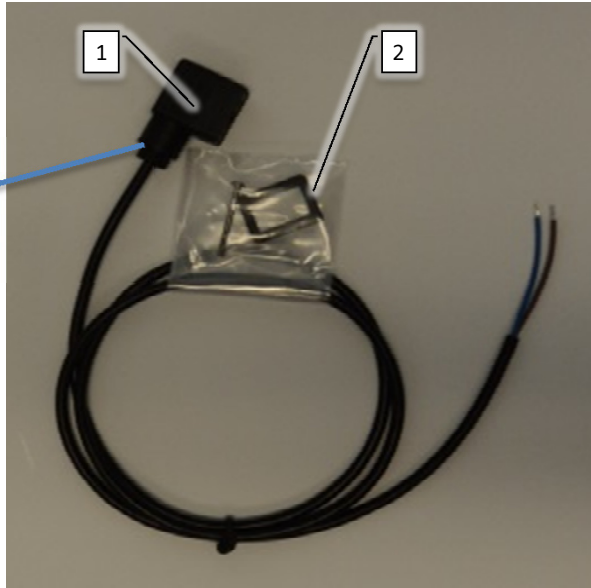
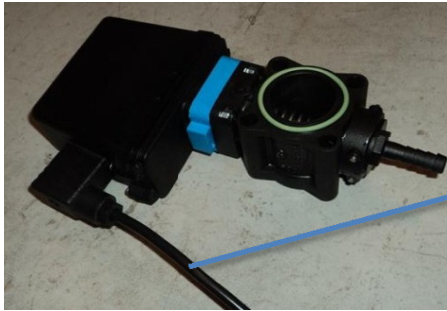

Pos	Psc	Number	Name	Price	Note
1	1	90517576	Stik for sektionsventil		
2	1	90517586	Pakning til stik (Form B)(90517576 )		
3	5,2	90400182	Kabel 18x0,75mm2 t/AB		
4	2,4	90100017	Plastflex 6mm		
5	0,09	90100011	Krympeflex Ø18,0-6,0mm		

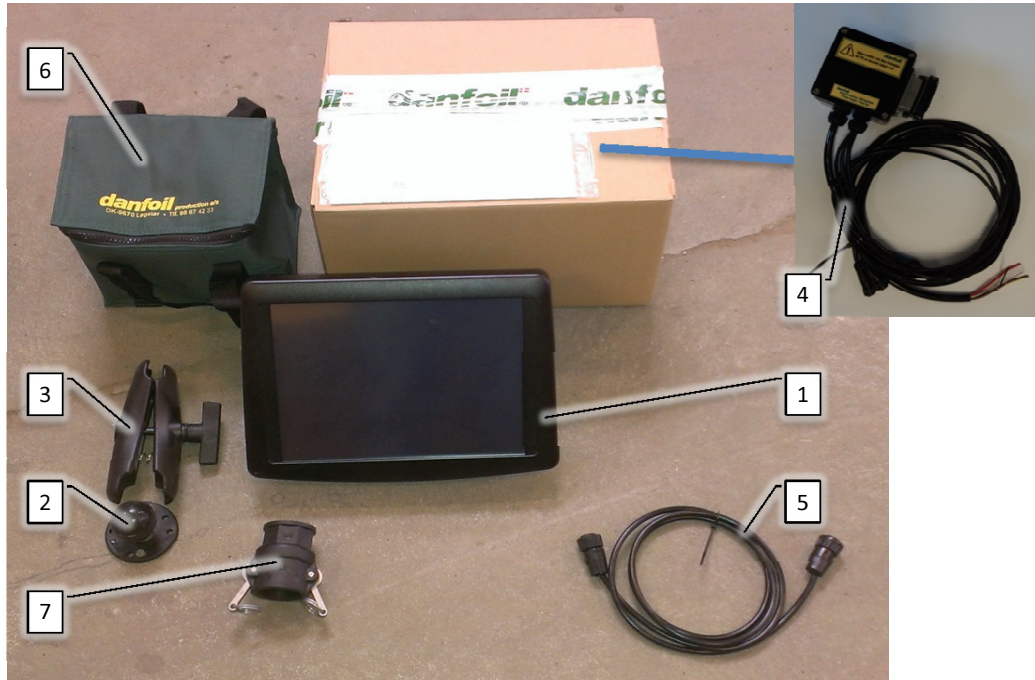

Pos	Psc	Number	Name	Price	Note
1	1	90404600	PC-Spray Controller V1		
2	1	90404617	Montagekugle PC (RAM 1 ½")		
3	1	90404618	Montagearm PC (RAM )		
4	1	90105010	Mont.sæt f/traktor PC styring std.		
5	1	90404607	Kabel 4x0,75 (PC-Joystick)		
6	1	20200008	Reserveedelspose i køletaske DK		
7	1	90320035	Lynkobling 1"- type B-hun-udv. gev		
8	1	BRUGERV.	Brugervejledning		

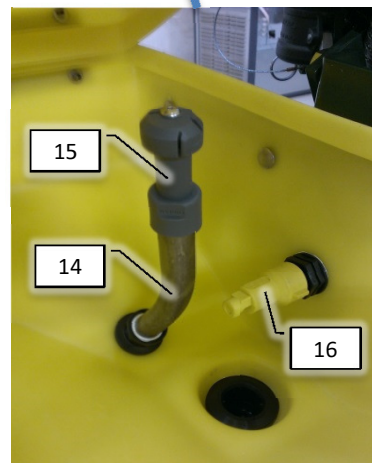
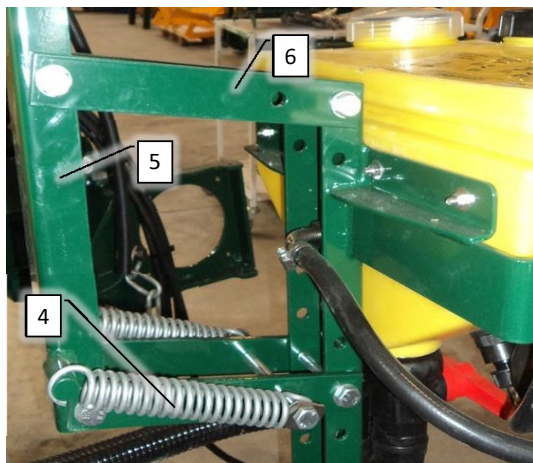
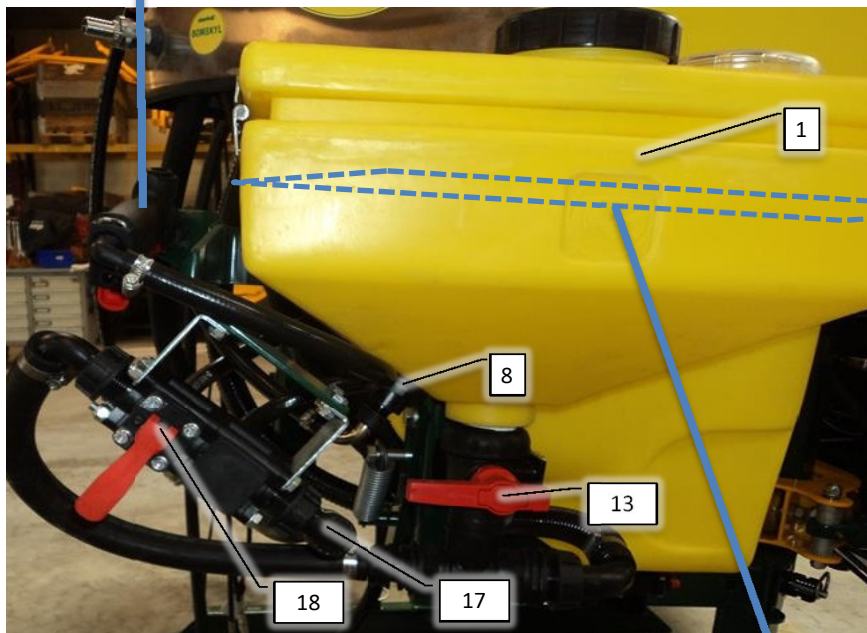

Pos	Psc	Number	Name	Price	Note
1	1	90320150	Kemifylder 20 liter Airboss		
2	1	90325056	Pistolgreb kemi.fylder		
		90325055	Nippel 1/2' Arag		
		90325048	Møtrik f. tankgennemf. 1/2" Arag		
3	1	90325032	Drøvle f/kemifylder AB		
4	2	90310051	Fjeder f.lås kemikaliefylder		
5	1	90330060	Beslag f.kemikaliesystem lang		
6	4	90330061	Plade f.kemikaliesystem		
7	1	90900112	Mærkat - kemifylder 3-sproget		
8	2	90325058	Reduktion 1/2' kemi.fylder		
10	1	90325065	Låg til kemi.fylder sort		
		90325071	Pakning til låg kemi. fylder		
11	1	90325070	Låg til kemi. fylder transparent		
		90325071	Pakning til låg kemi. fylder		
13	1	90325037	Ventil f bundsp f kemifylder		
14	1	90325059	Rør indiv. kemi.fylder		
15	1	90320185	Dunkspuler kemikaliesystem		
16	1	90325080	Dysehoved kemifylder gul 3 mm		
17	1,6	90340005	Slange 25 mm - tryk		
18	1	90325037	Ventil f bundsp f kemifylder		

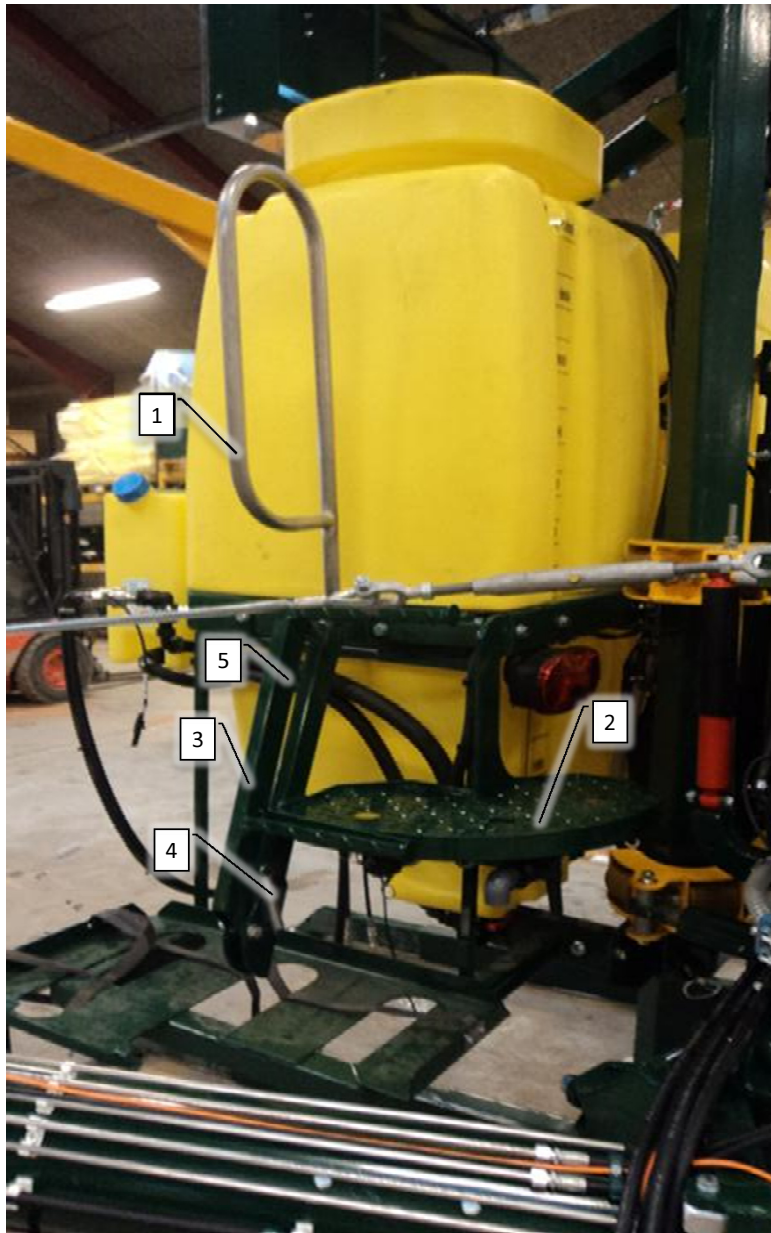



Pos	Psc	Number	Name	Price	Note
1	1	90330449	Gelænder for AB		
		1 90210241	Bolt M6x30 A2 buttonhead		
		1 90210053	Møtrik M6 FZB låse		
2	1	90330450	Trinbræt for AB		
	3	90210049	Bolt M12x25 FZB 8.8 ubryst		
	3	90214408	Skive M12 FZB Facet		
3	1	90330451	Stige for AB		
	1	90210041	Bolt M12x45 FZB 8.8 ubryst		
	2	90214408	Skive M12 FZB Facet		
	1	90210056	Møtrik M12 FZB låse		
4	1	90310070	Fjeder t. trinbræt AB		
5	1	90400143	Vibrationsdæmper f trinbræt		
	1	90900073	Mærkat - Påfyldning		

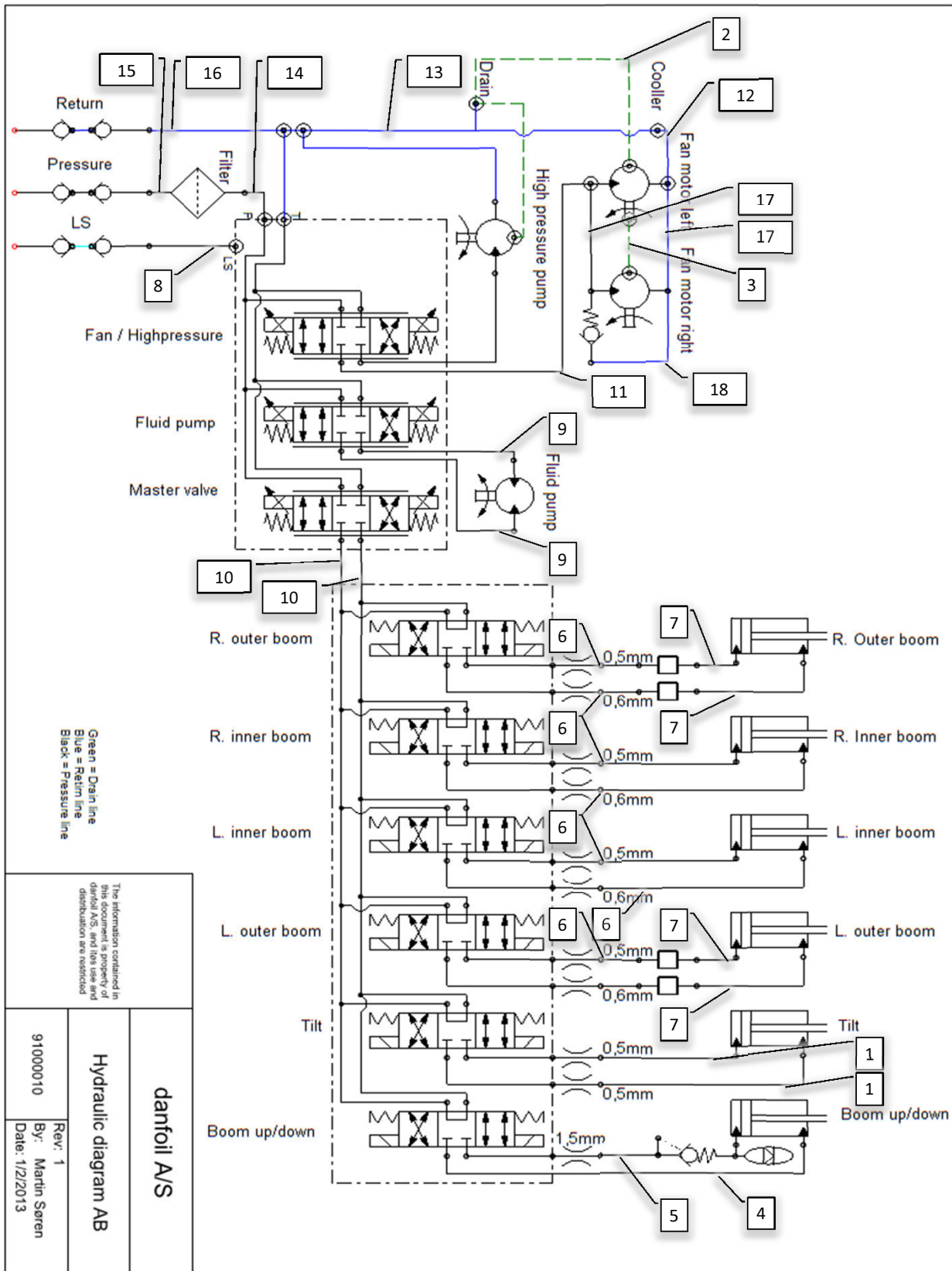

Pos	Psc	Number	Name	Price	Note
1	1	90515071	Hy slange 1/4' Tilt 4000 AB		
2	1	90515072	Hy slange 1/4'dræn 4100 AB		
3	1	90515073	Hy slange AB CCII 1/4'dræn 600mm		
4	1	90515074	Hy slange 1/4'lift 2200 AB		
5	1	90515075	Hy slange 1/4 lift 1100 AB		
6	1	90515076	Hy slange AB CCII 1/4'bom 4700mm		
7	1	90515170	Hy slange 1/4" bomslange t/rustfri 800mm		
8	1	90515077	Hy slange AB CCII 1/4' LS 1600mm		
9	1	90515078	Hy slange 3/8' væskep 2100 AB		
10	1	90515079	Hy slange AB 3/8'mellemsl 500mm		
11	1	90515080	Hy slange 1/2'blæser 3250 AB		
12	1	90515081	Hy slange 1/2'blæser 4200 AB		
13	1	90515082	Hy slange 5/8' retur 1600 AB		
14	1	90515083	Hy slange 5/8' filter 550 AB		
15	1	90515084	Hy slange 5/8' pumpe 1400 AB		
16	1	90515085	Hy slange 3/4'tank 1400 AB		
17	1	90515086	Hy slange AB CCII 1/2'motor 650mm		
18	1	90515087	Hy slange AB CCII 1/2' motor 550mm		

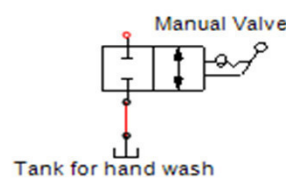
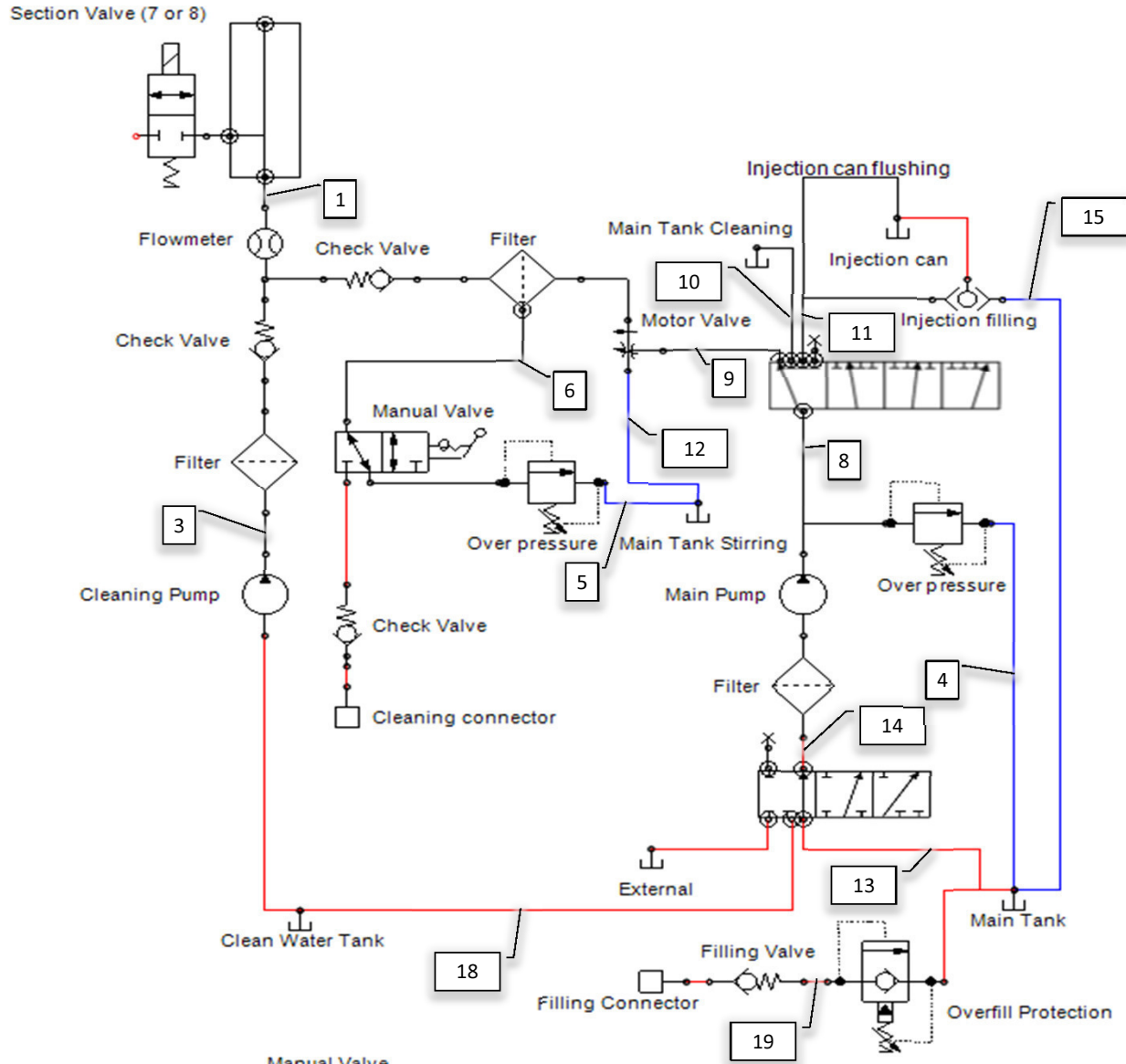

Red = Suction line  
 Blue = Return line  
 Black = Pressure line

The information contained in this document is property of danfoil A/S, and its use and distribution are restricted.	danfoil A/S	
	Water flow diagram Std. AB CC AC	
	91000020	Rev: 1 By: Martin Søren Date: 1/2/2013

Pos	Psc	Number	Name	Price	Note
1	3,5	90340004	Slange 19 mm - tryk		
3	2	90340003	Slange 13,0 mm - tryk		
4	3,4	90340000	Slange 16 mm tryk		
5	2,2	90340004	Slange 19 mm - tryk		
6	3	90340004	Slange 19 mm - tryk		
8	3,1	90340005	Slange 25 mm - tryk		
9	2,5	90340005	Slange 25 mm - tryk		
10	1,3	90340005	Slange 25 mm - tryk		
11	1,6	90340005	Slange 25 mm - tryk		
12	0,75	90340005	Slange 25 mm - tryk		
13	1,85	90340006	Slange 32 mm sug		
14	1,85	90340006	Slange 32 mm sug		
15	2,8	90340006	Slange 32 mm sug		
18	2	90340044	Slange 25 mm sug		
19	2,4	90340005	Slange 25 mm - tryk		

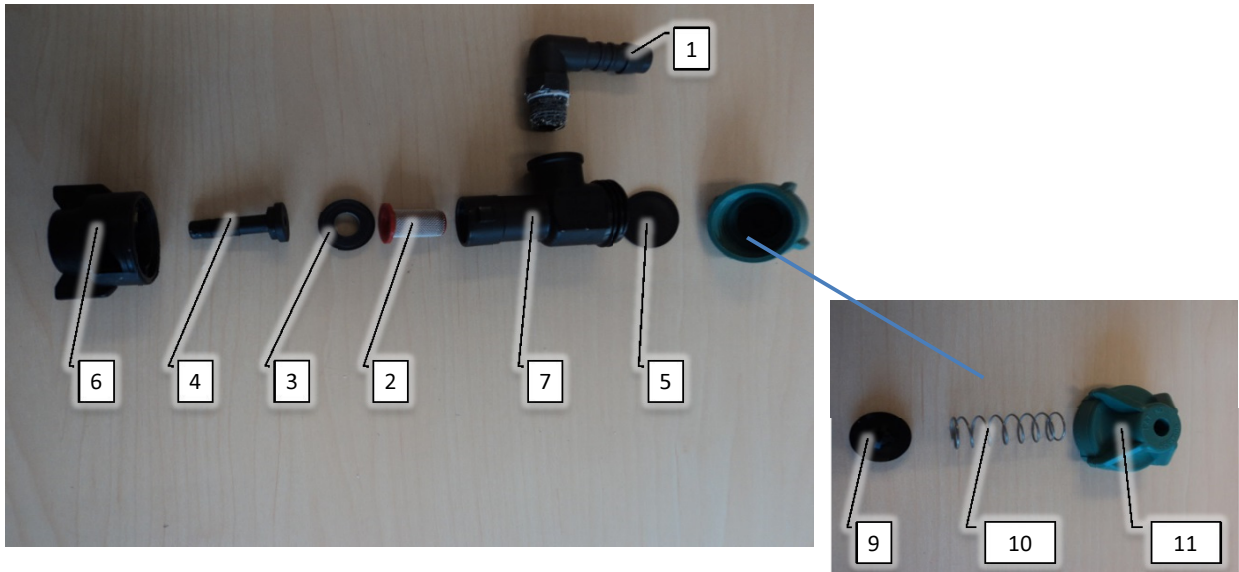

Pos	Psc	Number	Name	Price	Note
1	1	90320130	Slangeforsk.1/4"x10x90° Norma		
2	1	90326002	Filter f/ drypstop		
3	1	90326003	Pakning f/ drypstop		
4	1	90326004	Dysenippel 6 mm f. drypstop		
5	1	90326005	Membran f/ drypstop		
6	1	90326009	Kap f/ drypstop/pakning		
7	1	90326018	Hus t/drypstop		
8	1	90326030	Top t/drypstop samlet (grøn/sort)		
9	1	90326016	Tap til Top drypstop		
10	1	90326019	Fjeder t/drypstop		
11	1	90326027	top t/drypstop (grøn RAL6024)		

Side 17

Side 28

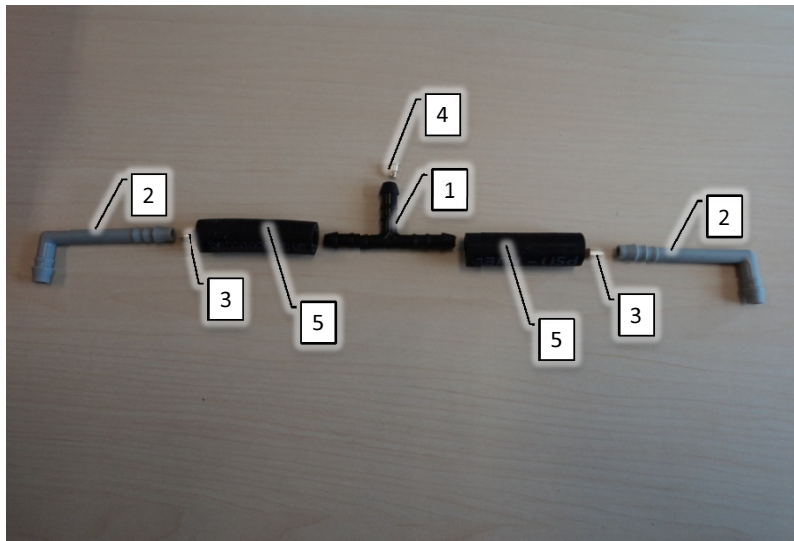



Pos	Psc	Number	Name	Price	Note
1	1	90320065	T-slangestuds 6 mm		
2	1	90320207	Vinkel t/forstøver 6 mm Grå		
3	1	90326007	Drøvle TJ 0,5		
4	1	90326008	Drøvle TJ 0,7		
5	0,1	90340001	Slange 6,3mm - tryk		

Side 14

Side 29

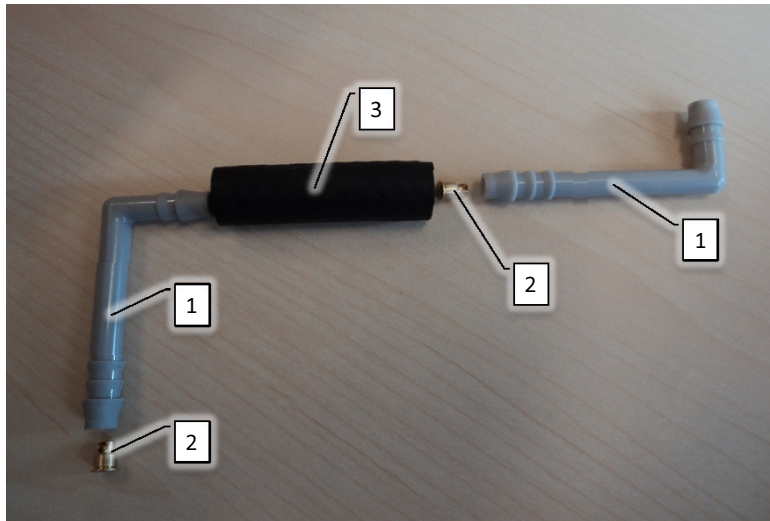

Pos	Psc	Number	Name	Price	Note
1	2	90320207	Vinkel t/forstøver 6 mm Grå		
2	2	90326007	Drøvle TJ 0,5		
3	0,05	90340001	Slange 6,3mm - tryk		

Side 14

Side 30

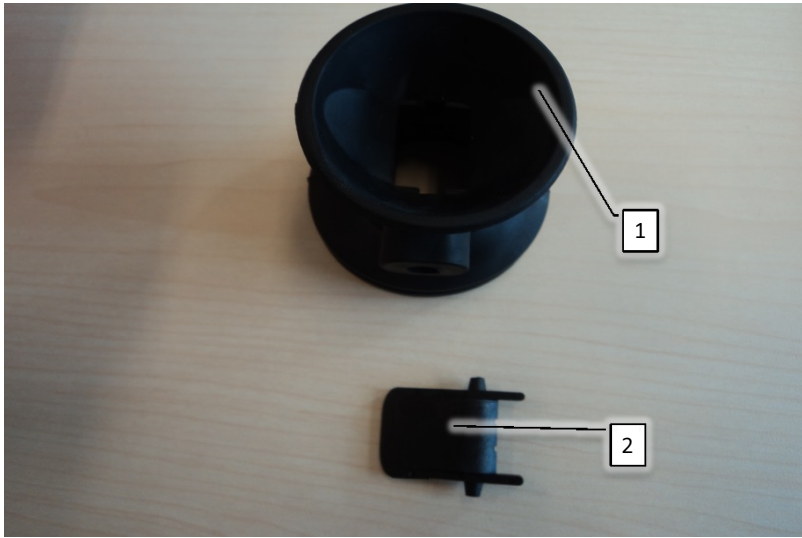

Pos	Psc	Number	Name	Price	Note
1	1	90320077	Eurofoil forstøver hus		
2	1	90320078	Eurofoil forstøverplade (afrundet kant)		

Side 14

Side 31

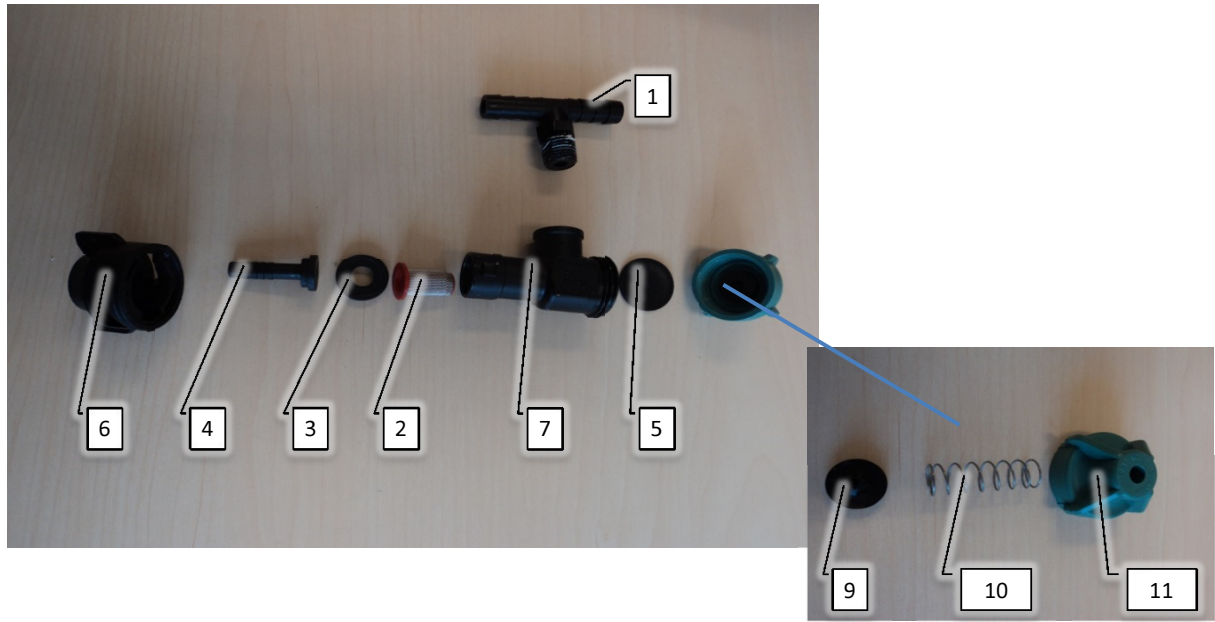

Pos	Psc	Number	Name	Price	Note
1	1	90326010	T-stykke 1/4' x 10m/m		
2	1	90326002	Filter f/ drypstop		
3	1	90326003	Pakning f/ drypstop		
4	1	90326004	Dysenippel 6 mm f. drypstop		
5	1	90326005	Membran f/ drypstop		
6	1	90326009	Kap f/ drypstop/pakning		
7	1	90326018	Hus t/drypstop		
8	1	90326030	Top t/drypstop samlet (grøn/sort)		
9	1	90326016	Tap til Top drypstop		
10	1	90326019	Fjeder t/drypstop		
11	1	90326027	top t/drypstop (grøn RAL6024)		

Side 18

Side 32

**danfoil®**

Jellingvej 14 | DK-9230 Svenstrup J

Tlf. +45 98 67 42 33

[www.danfoil.dk](http://www.danfoil.dk) | [info@danfoil.dk](mailto:info@danfoil.dk)

